

COMPLETE AGRICULTURAL IRRIGATION SOLUTIONS

Boost yields and save resources with an irrigation setup tailored to your agricultural conditions. From pump to plant and from conception to installation, benefit from a complete product portfolio and 360° service.

PIPELIFE 
always part of your life





CONTENT

One-Stop Irrigation Solutions Tailored to Your Needs	4
8 Service Steps to Maximal Yields and Crop Quality	6
Your Irrigation Product Guide From A to Z	8
Micro Irrigation Systems	10
Sprinkler Irrigation Systems	20
Water Supply Systems	24
Filtration Systems	30
Fertigation Systems	34
Automatic Control Valves	38
Irrigation Controllers	40
Irrigation Pumps	42

ONE-STOP IRRIGATION SOLUTIONS TAILORED TO YOUR NEEDS

With an irrigation setup tailored to your agricultural requirements, you can create the ideal conditions for crops to thrive. Increase yields, improve product quality and protect your soil while saving on precious time and resources.

As the choice of equipment and technologies is vast and there are multiple important aspects to consider for every part of an irrigation system, it can be challenging to piece together an optimal setup. Whether you are extending or updating your irrigation system or planning to build from scratch, we will make sure it is the right choice.

With decades of experience, expertise and close cooperation with farmers, our experts will make sure your investment is worth the while and you can benefit from your setup for years to come.

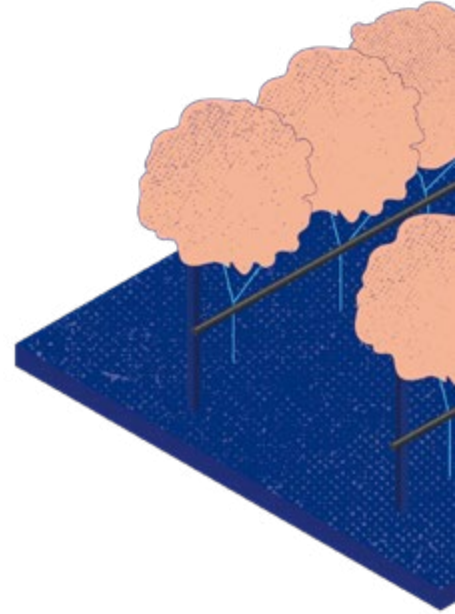

From pump to plant and from conception to installation, benefit from a complete product portfolio and 360° service to:

MAXIMIZE YIELDS

Produce to full plot capacity and increase yields per plant with ideal soil moisture throughout.

IMPROVE CROP QUALITY

Get the most out of each plant and consistently produce top quality.

MINIMIZE FERTILIZER USE

Save on nutrients and other chemicals thanks to efficient appliance.



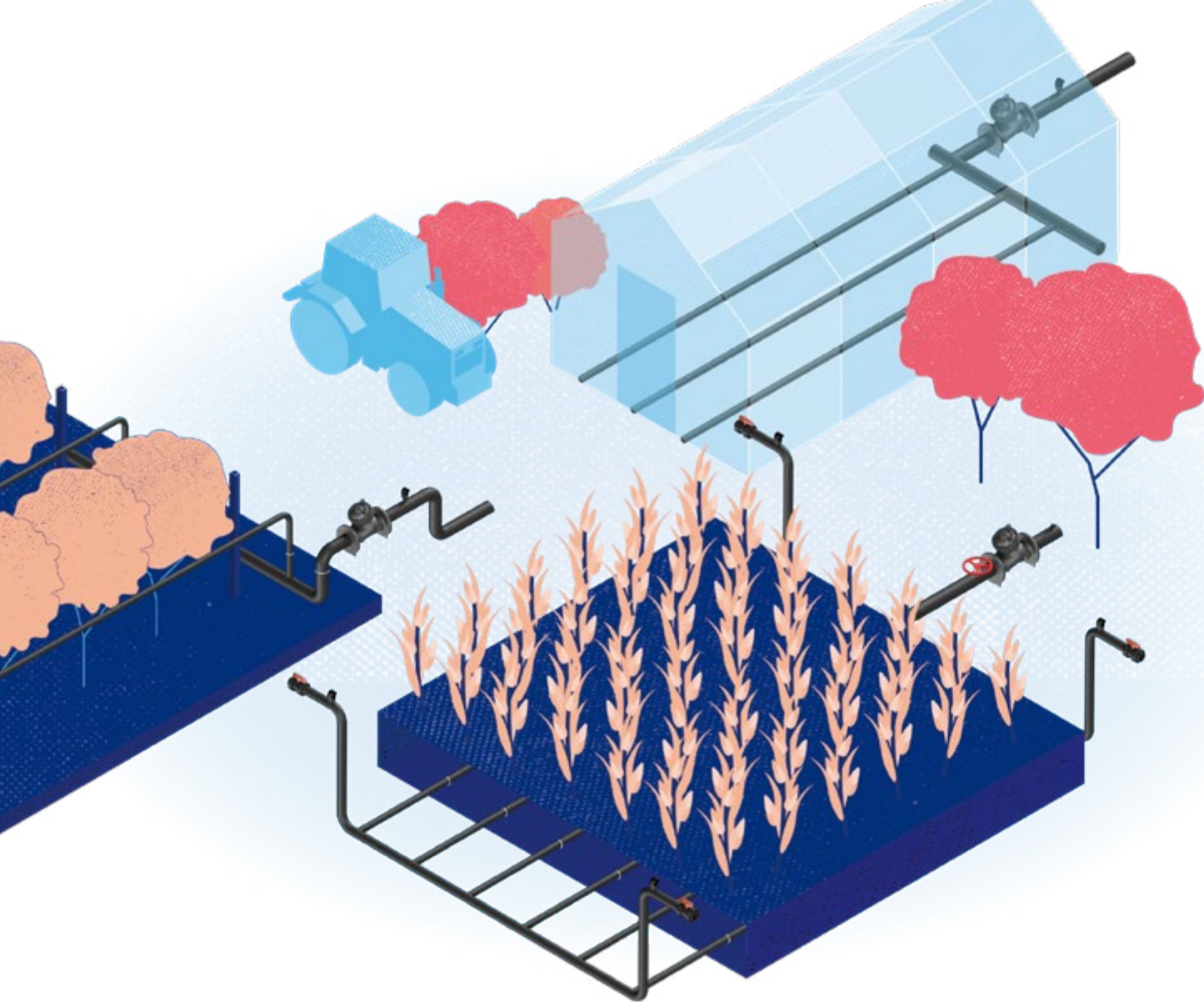

USE LESS ENERGY

Minimize operating pressures and related energy consumption.

USE LESS WATER

Save up to 65% water by making sure it only goes where it is needed.

REDUCE LABOR

Opt for partially to fully automated irrigation and let the system work for you.

MINIMIZE DISEASE CONTROL

Increase plant health with optimal, consistent soil humidity and nutrient conditions.

REDUCE WEEDING COSTS

Save up to 35% weeding costs, especially with drip irrigation.

PROTECT YOUR SOIL

Avoid erosion and keep salinity levels up for sustainable land use.

8 SERVICE STEPS TO MAXIMAL YIELDS AND CROP QUALITY

No need to worry about what's best for your plot and crop: Our experts are at your side, every step of the way. Make an informed choice based on decades of experience and expertise in irrigation equipment and farming knowledge gained through close cooperation with farmers.

WE'LL WALK YOU THROUGH OUR 360° SERVICE IN 8 SIMPLE STEPS:

1.

Let's meet; we'll listen — you know your plots and crops best.

Based on your operating and production methods, crop types and conditions of the land you cultivate, we will present you all suitable irrigation methods pointing out their advantages and disadvantages. You will be able to make an informed decision about what suits you best.

2.

Designing a perfect match for efficient and lasting operation.

Our engineers will calculate, select and dimension every element of your irrigation setup for an engineered design. It will ensure reliable and even irrigation to maximize your plantation area and results while keeping resources and running costs to a minimum.

3.

Expect a turnkey solution at a guaranteed price.

No need to worry about hidden or additional costs. You can count on a professional quotation based on a product listing including everything to the very last bolt. At this point, and if applicable, you will also receive a quotation for installation costs.

4.

Are you eligible for financial support? Let's find out.

There are various national and European funds to which you may have access. Not every investor fulfills the necessary criteria for grants, but it's worthwhile checking the possibilities. We'll advise and support you in this and preparing required documentation, delivery timing and commissioning.

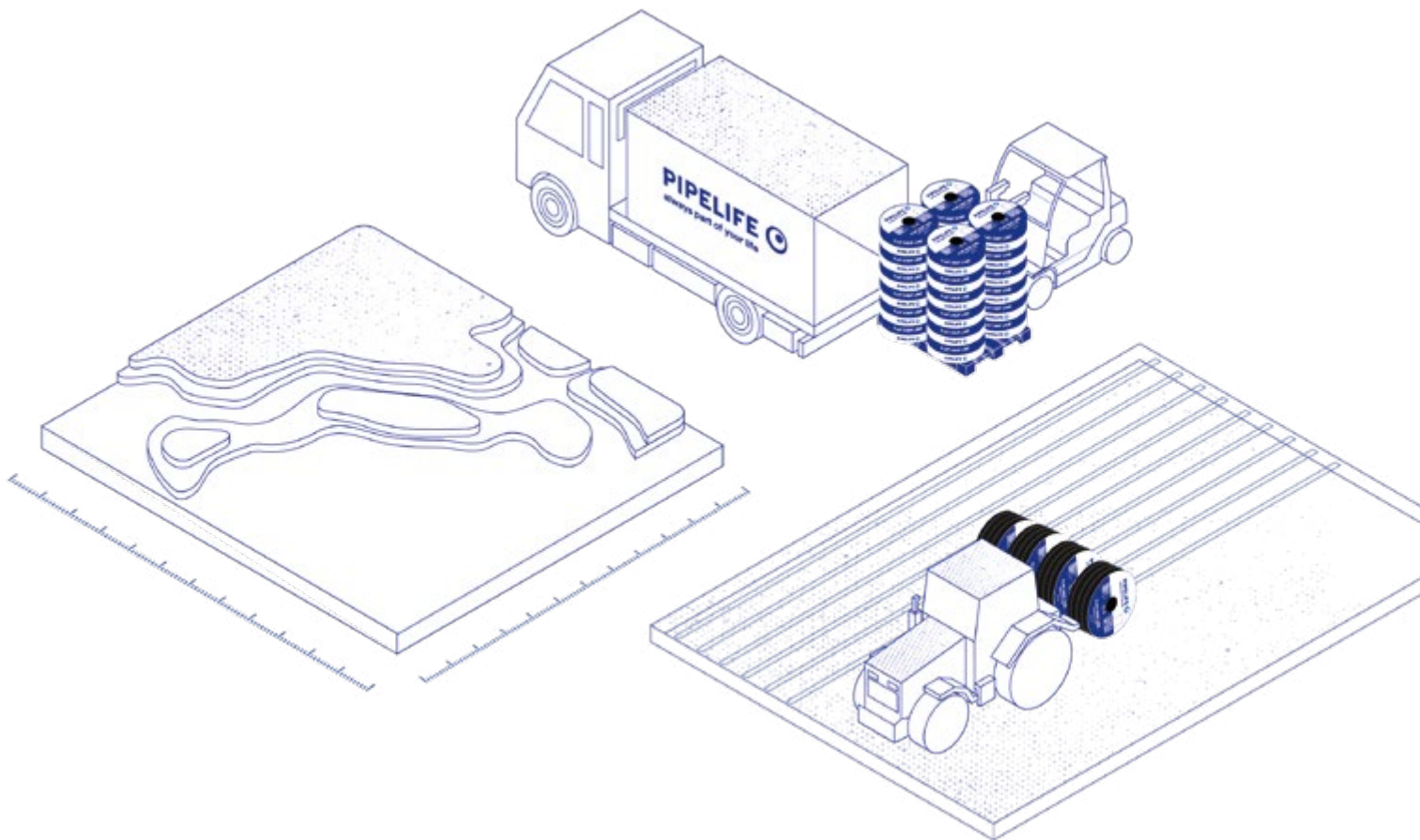

5.

No need to wait or worry; we'll make sure you're delivered on time.

Timely deliveries are crucial especially for seasonal businesses such as yours. Also, grants may include agreements on delivery, installation and commissioning times that need to be respected. There is no need for you to juggle multiple parties, we'll make sure everything is in place at the right time.

6.

Everything runs according to plan, right up to installation and startup.

With one of our trusted local installation partners and a PIPELIFE expert supervising the works on-site, you can be sure your irrigation setup is built exactly according to the planned design. Starting your system up for the first time will be exciting because you already know that commissioning is going to be a success.

7.

We'll make you feel at ease working with your system, right from start.

In addition to having been recommended user-friendly technology, you will receive all the instruction material and training you need to understand how to operate, manage and maintain your irrigation setup.

8.

Count on continued support and a warranty on maintenance service.

On top of being available to you with support and know-how throughout the irrigation season, we provide you with a warranty period of 24 months for maintenance service and spare parts.

YOUR IRRIGATION PRODUCT GUIDE FROM A TO Z

You know best what your crops need, and we are experts in providing the right equipment for you to achieve optimal conditions. Browse through the following product pages to gain an overview of the broad range of irrigation equipment and systems we offer – either from our production or from our carefully selected partners. Find out what criteria to pay attention to when choosing components for your irrigation setup.

Get in touch with us for further information and in-depth specifications of each product line or system. Our experts will be happy to assist.

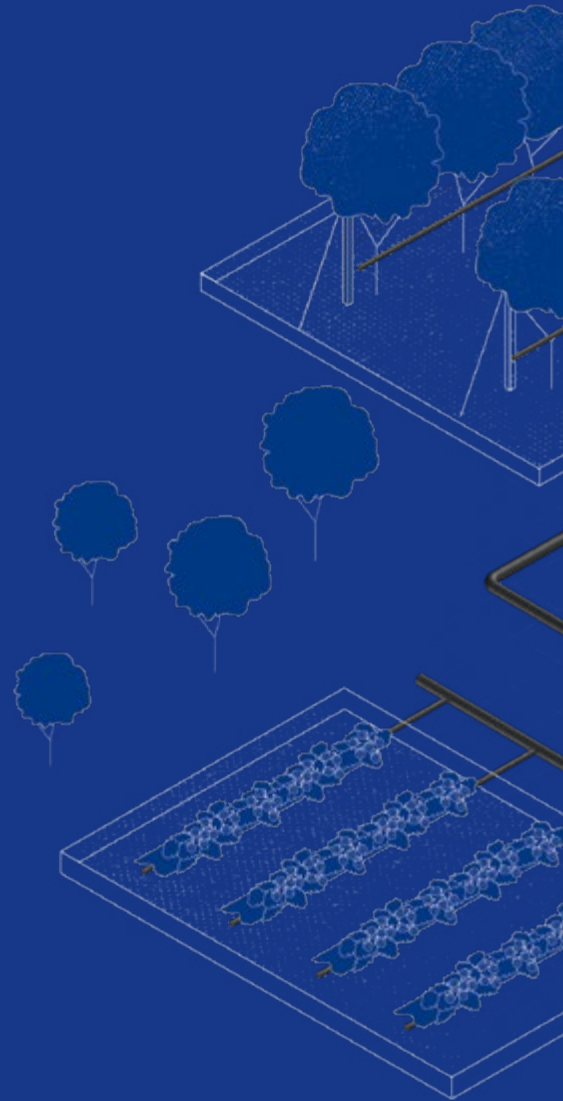

ACHIEVING PROFITABILITY AND OPTIMAL RETURN ON INVESTMENT

Buying the most expensive equipment available doesn't necessarily lead to the best results. Agreed, good quality comes with a price, but a good investment should create tangible benefits. Maximum profitability and a favorable return on investment are ensured when:

Every part of your irrigation system is tailored to your individual needs and preferences.

There is complete compatibility and an impeccable interplay between all irrigation components and technologies.

You can count on efficient and effective project implementation, handover and service.

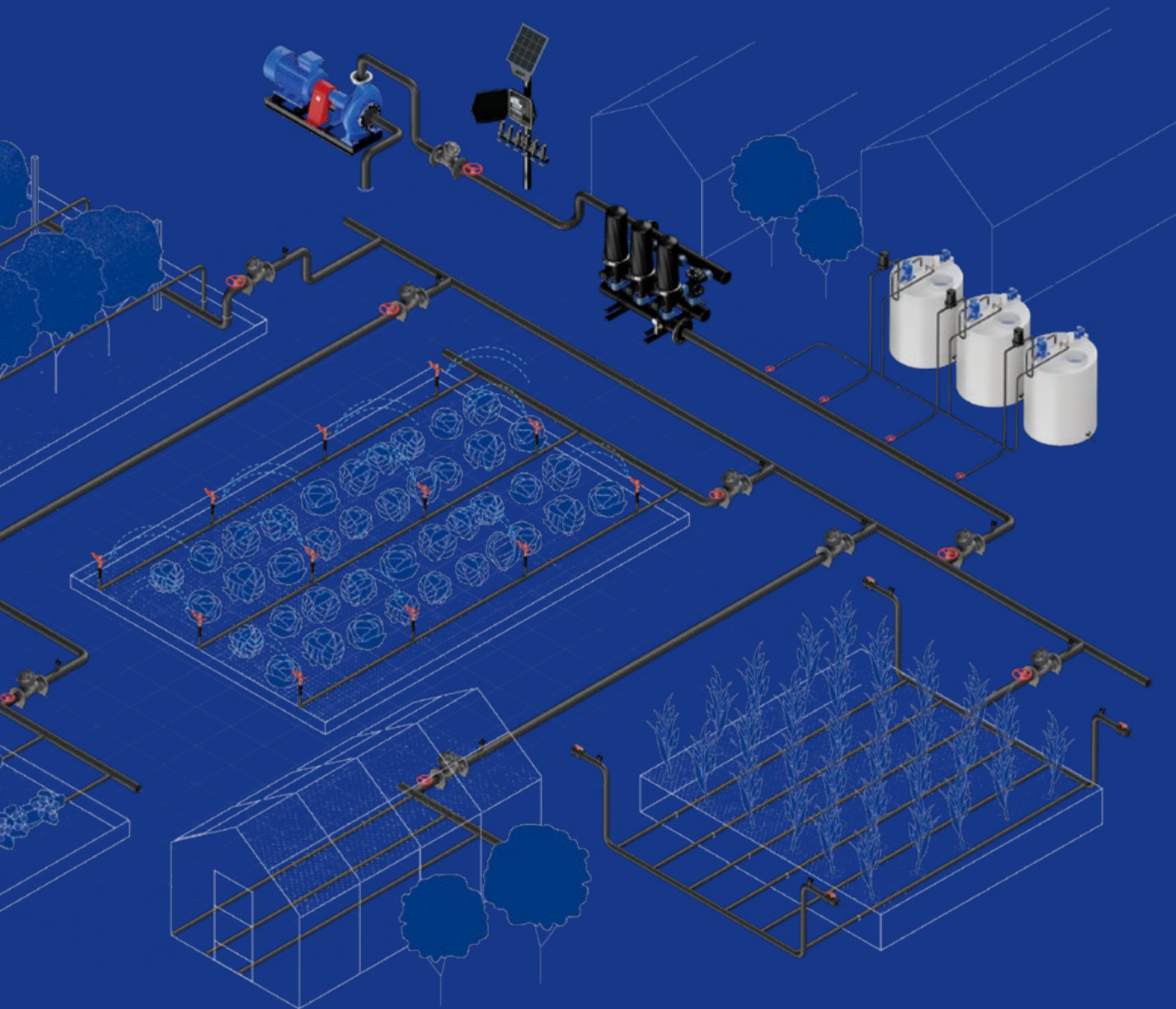

A CHOICE TAILORED FOR SUCCESS

Here are the key factors that need to be taken into consideration when it comes to choosing each part of your irrigation setup:

- **Water source and quality**
- **Cultivation practices**
- **Plot size and layout**
- **Topography**
- **Soil conditions**
- **Crop type**
- **Climate**
- **Personal preferences**
- **Budget**

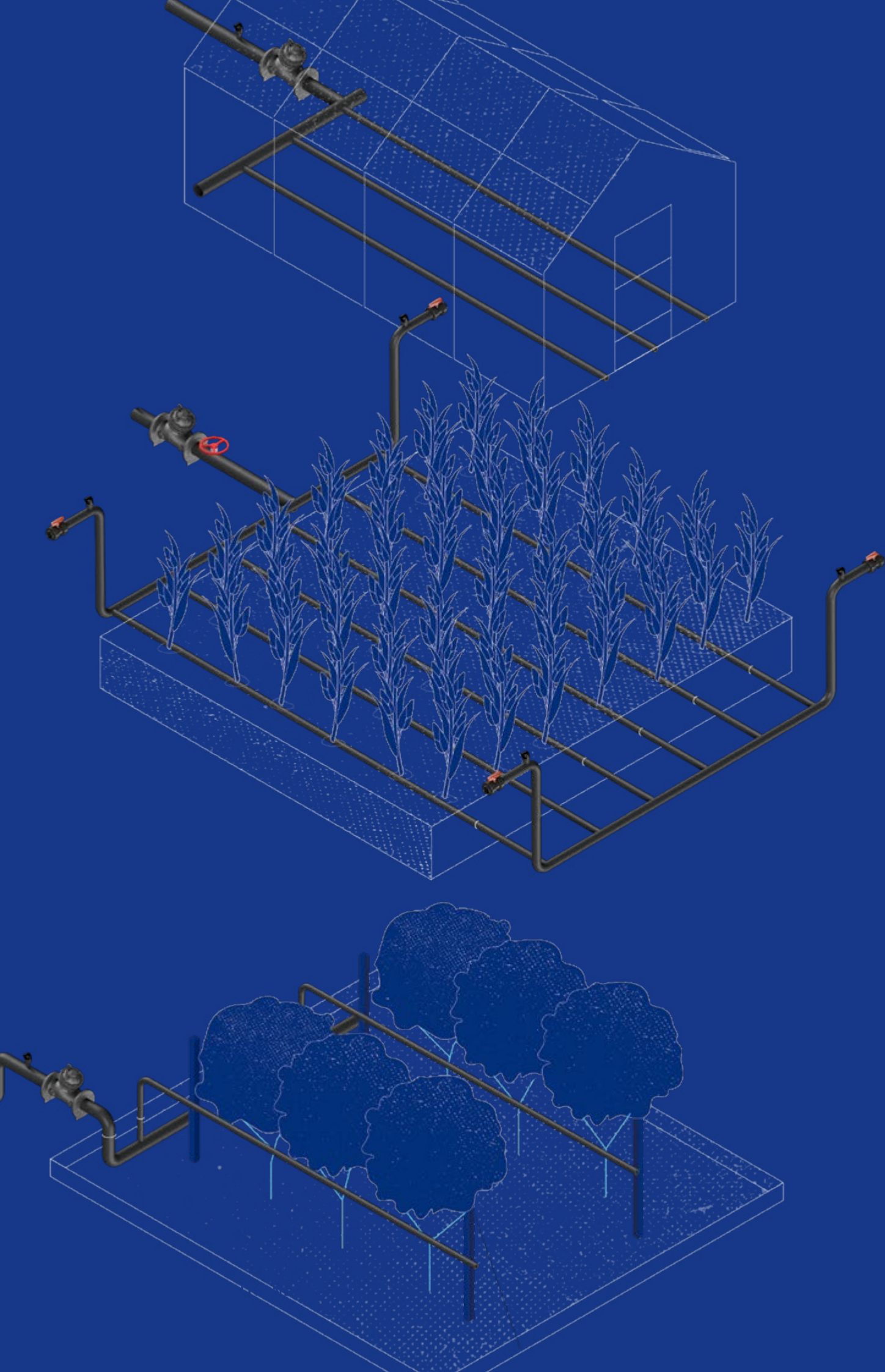

MICRO IRRIGATION SYSTEMS

Thanks to high-precision technology, micro irrigation is the most water and nutrient-saving method available in agriculture. Apart from economic and ecological benefits, micro irrigation is also the most accurate method to deliver each plant precisely what it needs to thrive. With an adequate micro irrigation system, you can maximize yields, uniformity, and your plantation area.

Our experts will recommend the system and individual specifics that best suit your agricultural setup, water and plot conditions, crop types, and preferences from our vast range of high-quality micro irrigation equipment.

Expect top-quality piping material, dripper design and micro-sprinklers for easy installation and hassle-free seasons.



ROUND DRIP PIPES

We recommend round drip pipes with inline drippers for smaller plots and multi-seasonal use. The system is ideal for many fruits crops with small plant spacing. Pressure compensated (PC) inline drippers come in handy when water pressure varies, on uneven terrain, and when crops are highly susceptible to fluctuations in soil humidity. Thanks to the anti-siphon design, our PC drip pipes are also fit for subsurface irrigation.

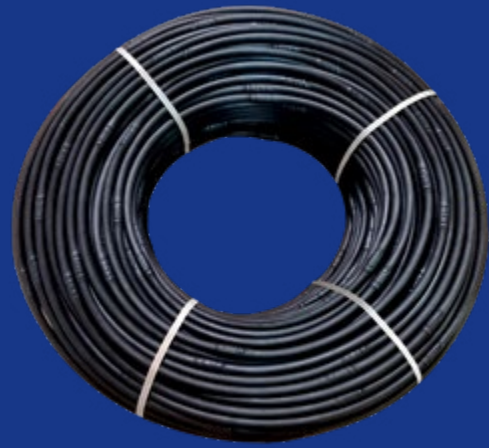

WITH STANDARD INLINE DRIPPERS



TECHNICAL DETAILS

Flow rate in l/h: 1, 2, 4

Dripper spacing in cm: 30, 50, 60, 75, 100

Pipe diameters in mm: 16 – 20

Wall thickness in mm: 0.9, 1.1

APPLICATIONS

- Number of seasons: multi-season
- Topography: flat
- Soil types: all
- Placement: on surface,
- Greenhouses, row crops, fruit orchards, vineyards, olive groves

WITH PC INLINE DRIPPERS



TECHNICAL DETAILS

Flow rate in l/h: 1, 2, 3, 4

Dripper spacing in cm: 30, 50, 60, 75, 100

Pipe diameters in mm: 16 – 20

Wall thickness in mm: 0.9, 1.1

APPLICATIONS

- Number of seasons: multi-season
- Topography: slopy
- Soil types: all
- Placement: on surface, sub-surface,
- Row crops, orchards, vineyards, olive groves

ACCESSORIES



FLAT DRIP LINES

Flat drip lines are the most versatile piping solution in drip irrigation. Thanks to the vast range of properties available regarding flow rate, dripper spacing, dripper design and wall thicknesses, we can customize your drip irrigation equipment to suit virtually any row crop or vegetable for single or multiple season use.

Although filtering is always a prerequisite in drip irrigation, flat drip line drippers have proven to be less sensitive to sand particles than other drippers. Pressure compensated (PC) flat drip lines are favored on uneven terrain or slopes, with fluctuating water pressure, or for plants that are highly susceptible to variations in soil humidity. PC drip lines can also be applied for subsurface irrigation.



WITH MICRO OR MIDI DRIPPERS



TECHNICAL DETAILS

Dripper type: integral, flat, midi, non-PC

Dripper flow rates in l/h: 0.8, 1.0, 1.2, 1.6, 2.2

Dripper spacing in cm: 10, 15, 20, 30, 33, 40, 50, 60, 70, 80

Line diameters in mm: 16, 22

Wall thickness in mm: 0.13, 0.15, 0.20, 0.25, 0.30

APPLICATIONS

- Number of seasons: 1-3 years
- Topography: flat
- Soil types: all
- Placement: on surface, mulching
- Row crops, vegetables, berry orchards

WITH FLAT PC DRIPPERS



TECHNICAL DETAILS

Dripper type: integral, flat, PCAS Pressure Compensated Anti-Siphon

Flow rates in l/h: 1.0, 1.6, 2.0, 3.8

Dripper spacing in cm: 20, 30, 33, 50, 60, 70, 80, 100

Line diameters in mm: 16 – 20

Wall thickness in mm: 0.38, 0.45, 0.60, 0.90, 1.00, 1.20

APPLICATIONS

- Number of seasons: multi-season
- Topography: flat, slopy
- Soil types: all
- Placement: on-surface, sub-surface
- Greenhouses, row crops, fruit orchards, vineyards, olive groves

ACCESSORIES



DRIP TAPES

Drip tapes are a standard go-to drip irrigation solution that offers a good cost-value ratio. They are primarily applied in vegetable farming. When choosing drip tape, it is important to watch the quality of the tapes' filtration area where the water is released. Laser technology is, for instance, used for high-quality drip tapes to avoid soil ingestion and root intrusion. Large, seamlessly integrated filtration areas and a low emitter profile are essential quality criteria to ensure uniform water flow.



WITH INTEGRATED LABYRINTH



TECHNICAL DETAILS

Dripper type: seamlessly integrated labyrinth, laser-cut slit

Flow rates in l/h: 0.6, 1.0, 1.5

Dripper spacing in cm: 10, 20, 30, 40

Tape diameters in mm: 16, 22

Wall thickness in mm: 0.15, 0.20

APPLICATIONS

- Number of seasons: 1 year
- Topography: flat
- Soil types: all
- Placement: on surface, sub-surface, mulching
- Row crops, vegetables

ACCESSORIES



PE IRRIGATION PIPES

Wherever the spacing between plants exceeds 3 meters, such as for apricot or quince orchards, blind pipes can be flexibly applied with online PC (pressure compensated) and ND (non-drain) drippers or micro-sprinklers on flat and uneven terrain. With a microtube and pick, online drippers are used to uniformly water potted plants.



TECHNICAL DETAILS

Diameters in mm: 16, 20, 25

Wall thickness in mm: 0.90 to 2.3

Nominal pressure in bar: 4, 6, 8

Coil lengths in m: 100, 200, 400

Material: PE 40

APPLICATIONS

- Number of seasons: multi-season
- Placement: on surface
- Installation with online drippers or micro-sprinklers



WITH PC AND ND ONLINE DRIPPERS



TECHNICAL DETAILS

Dripper type: pressure compensated (PC) and non-drain (ND)

Flow rates in l/h: 2.2, 4.0, 8.0

Working pressure in bar: 1 to 4

APPLICATIONS

- Terrain: flat, slopy
- Fruit orchards, olive groves, greenhouses, row crops

ACCESSORIES



WITH MICRO SPRINKLERS



TECHNICAL DETAILS

Nominal flow rates in l/h: 30 to 120

Working pressure in bar: 1.5 to 2.5

Irrigation diameter in m: 5.5 to 9.0

APPLICATIONS

- Orchards, vegetables, greenhouse irrigation and cooling

ACCESSORIES



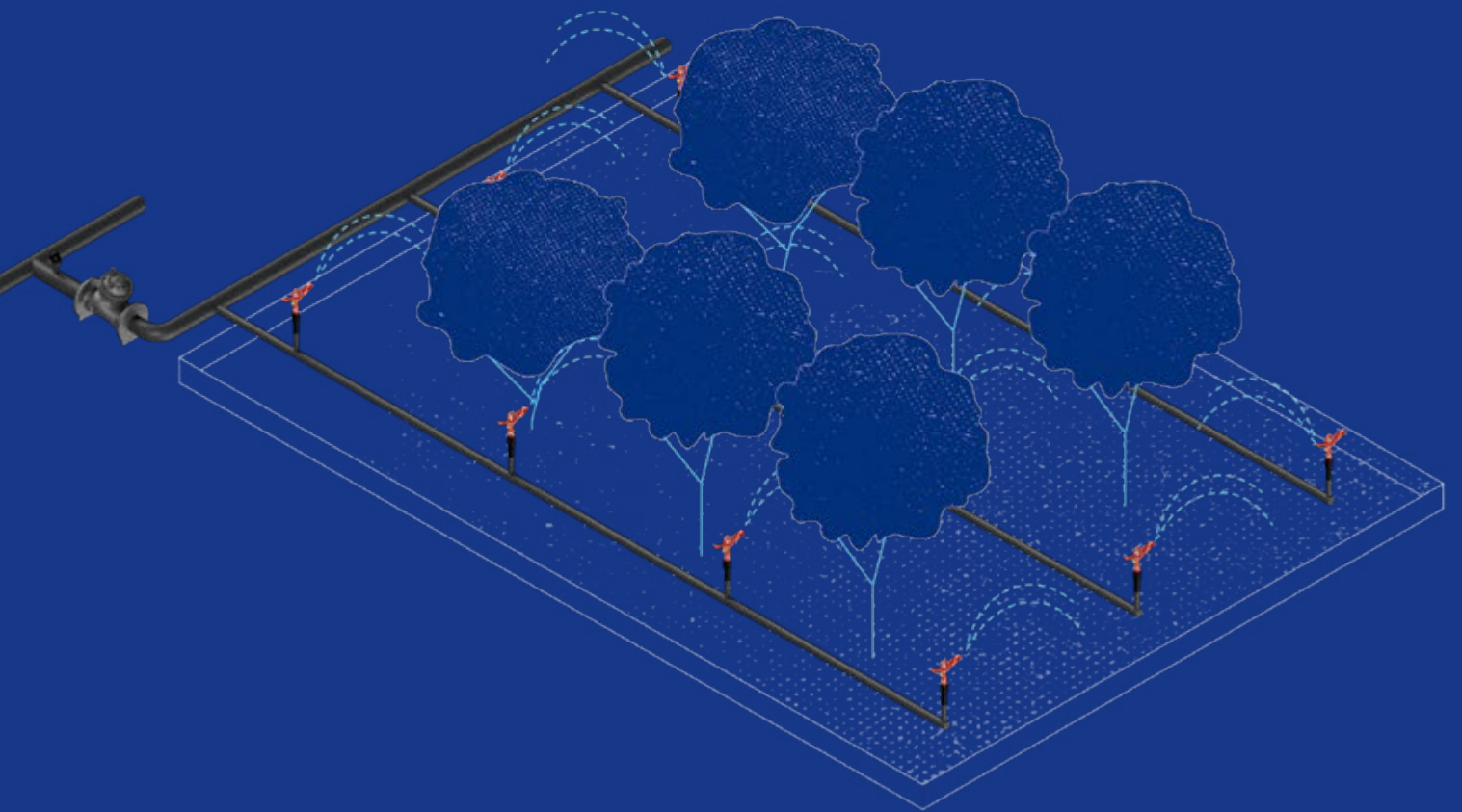
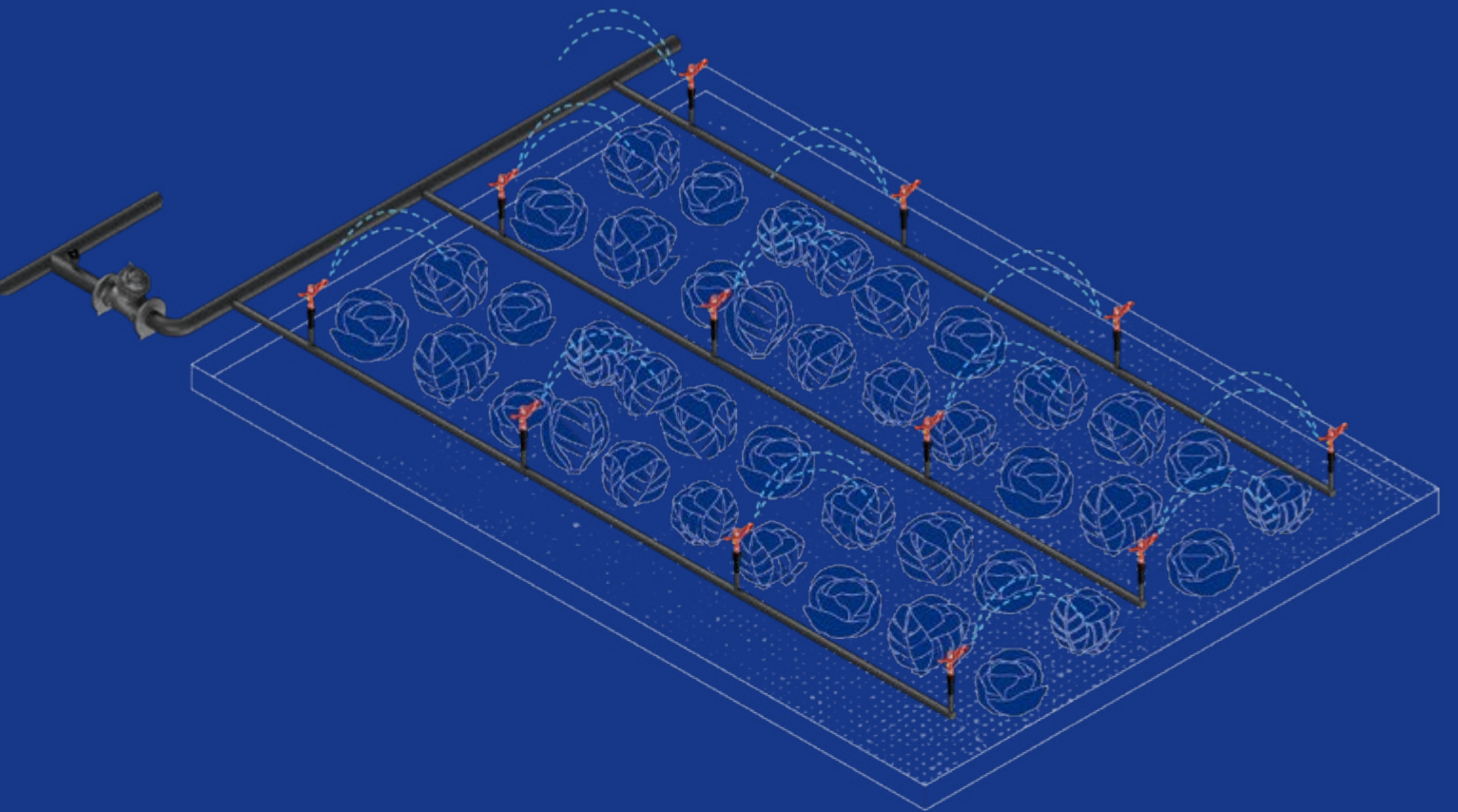

SPRINKLER IRRIGATION SYSTEMS

We recommend PE sprinkler irrigation systems for crops and plants that thrive best when watered from above. Quick and easy jointing systems like PIPELIFE's latch or clamp systems ensure time-efficient installation and removal. Your sprinkler system should be light but sturdy enough to resist frequent transportation and handling.

Good quality equipment with reliable sealing systems remains leak-tight even under low-pressure conditions. Our high-performance sprinklers provide uniform and precise water distribution that comes close to the natural rain.





SPRINKLERS



TECHNICAL DETAILS

NOZZLE	PRESSURE (bar)	FLOW RATE (m ³ /h)	IRRIGATION DIAMETER (m)
5.0 x 4.0	3.0	2.000	20
	4.0	2.200	24
5.0 x 2.3	3.0	1.600	20
	4.0	1.800	24
4.2 x 2.3	3.0	1.450	20
	4.0	1.600	24
3.8 x 2.3	3.0	1.350	20
	4.0	1.500	24
3.2 x 2.3	3.0	1.200	20
	4.0	1.300	24

APPLICATIONS

- All field crops

SPRINKLER PIPE LATERALS



TECHNICAL DETAILS

Pipe diameters in mm: 50, 63, 75, 90, 110, 125, 140, 160, 200

Pipe lengths in m: 5 – 6

Nominal pressure (PN): 4, 6, 8, 10

Material: PE 100

ACCESSORIES



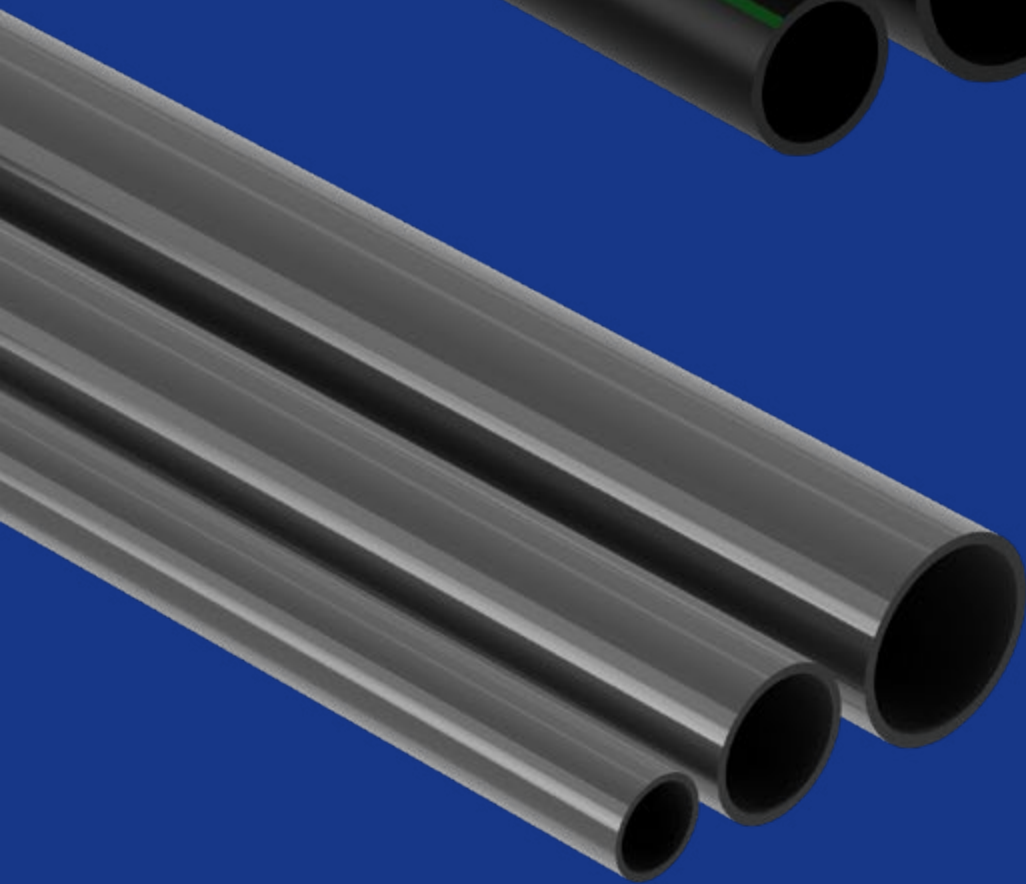
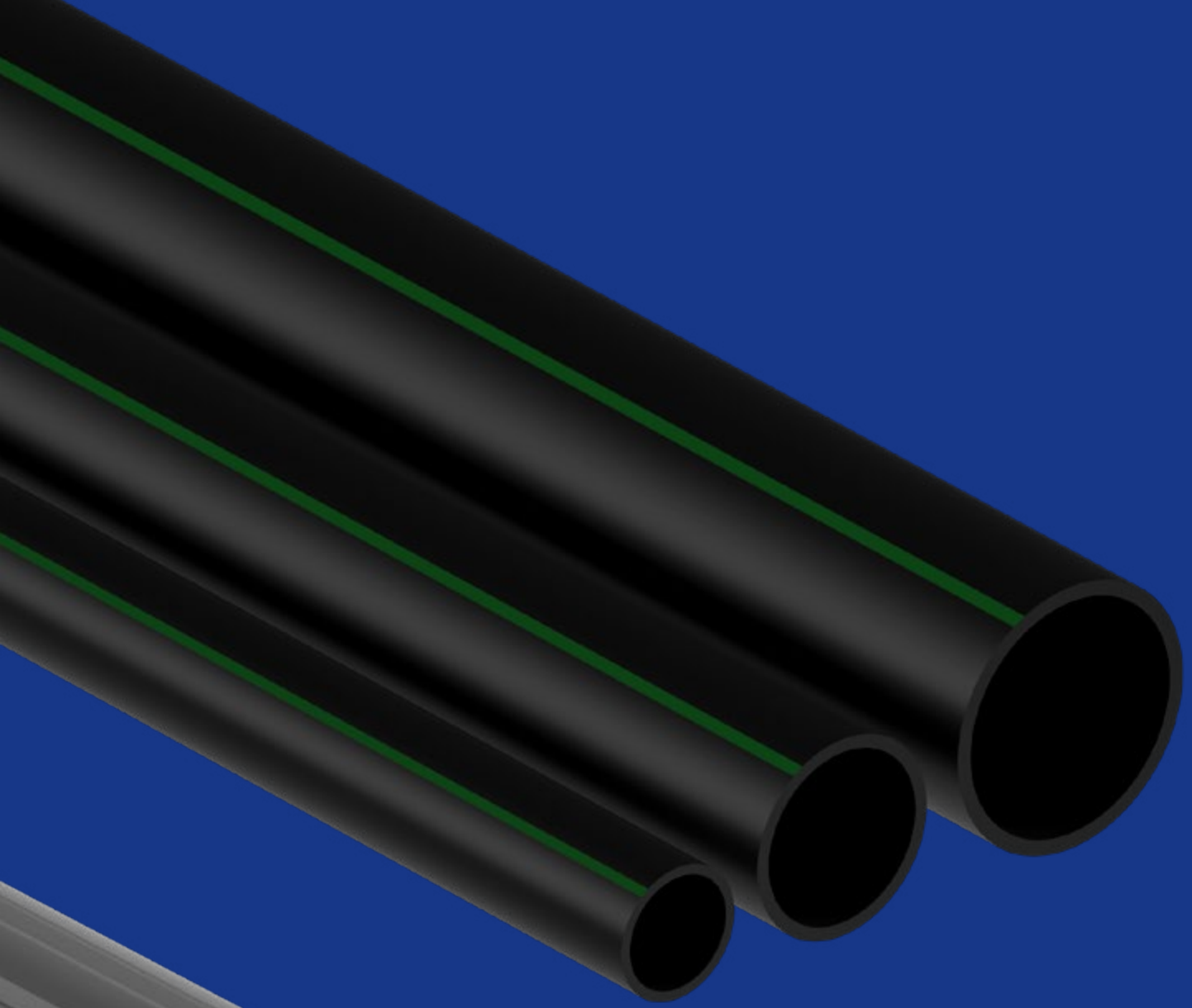

WATER SUPPLY SYSTEMS

An adequate piping system will ensure trouble-free growing seasons and a long service life for your irrigation setup with minimal maintenance. You can choose from an extensive range of materials and piping solutions for water supply on the market. As an experienced manufacturer of piping systems, we recommend selecting materials and products that are best suitable for the respective application. A water main, for instance, requires different properties and characteristics than the connections between your irrigation equipment. The setup of your plot, the size of your project, the applied irrigation methods, and your preferences play a defining role.

Whichever system you choose, always opt for good-quality products from reliable producers to avoid ruptures, leakage and consequent pipe replacement. Depending on where leaks occur, they may not only harm or ruin crops but can also lead to costly damages to structures and buildings, not to mention extensive irrigation downtimes during growing periods.



HDPE 100 PIPES



The safest and most durable pipes for underground water supply mains, sub mains and section lines are made from HDPE (high-density polyethylene), also called PE pipes. With an extensive range of diameters, PE pipes are used for all underground lines, from the water supply main through the main distribution lines to the sub-mains. Flexible yet sturdy, and with high impact strength and chemical resistance, they offer optimal hydraulics and maintenance-free service life of 100 years.

Our PE pipes are produced and tested to stringent drinking water (potable water) standards, using only high-quality raw materials and state-of-the-art production technology.

TECHNICAL DETAILS

Diameters in mm: 25 to 400

Wall thickness in mm: 1 to 40

Nominal pressure (PN): 6, 8, 10, 16

Coil length: 50 to 100 m

Standard pipe lengths in m: 6, 12

APPLICATIONS

- Potable water supply
- Irrigation water supply
- Water supply for firefighting

ACCESSORIES

COMPRESSION FITTINGS PN16, DN20 TO DN110



ELECTROFUSION



SPIGOTS



PVC LAY FLAT HOSE



Insensitive to UV exposure, lay flat hoses are used for water supply lines above ground, especially for section lines feeding drip irrigation laterals and mobile sprinkler systems. Light in weight, flexible, sturdy and easy to connect, they offer quick installation and take up little space when re-coiled for winter. We recommend flat hoses made of PVC for maximal durability and trouble-free irrigation seasons.

TECHNICAL DETAILS

Diameter in mm: 53, 65, 78, 105

Working pressure in bar: 3, 4, 6

Coil length: 100 m

Material: PVC

APPLICATIONS

- Water supply and discharge
- Drip irrigation systems
- Drainage for mobile sprinkler systems

ACCESSORIES



PVC PIPE SYSTEMS



PVC pipe systems are used to connect pumps, filter, fertigation and other irrigation equipment and are also handy for micro-sprinkler systems in greenhouses. They are appreciated for being light, their easy and reliable jointing system, and their high resistance to chemicals, elevated temperatures and UV exposure.

A wide range of diameters and fittings is essential to implement more complex connections.

TECHNICAL DETAILS

Nominal diameters in mm: 25 to 110

Nominal pressure in bar (PN): 16

Material: PVC

Production standard: EN 1452-3

APPLICATIONS

- Connections between equipment
- Greenhouse sprinkler system

ACCESSORIES





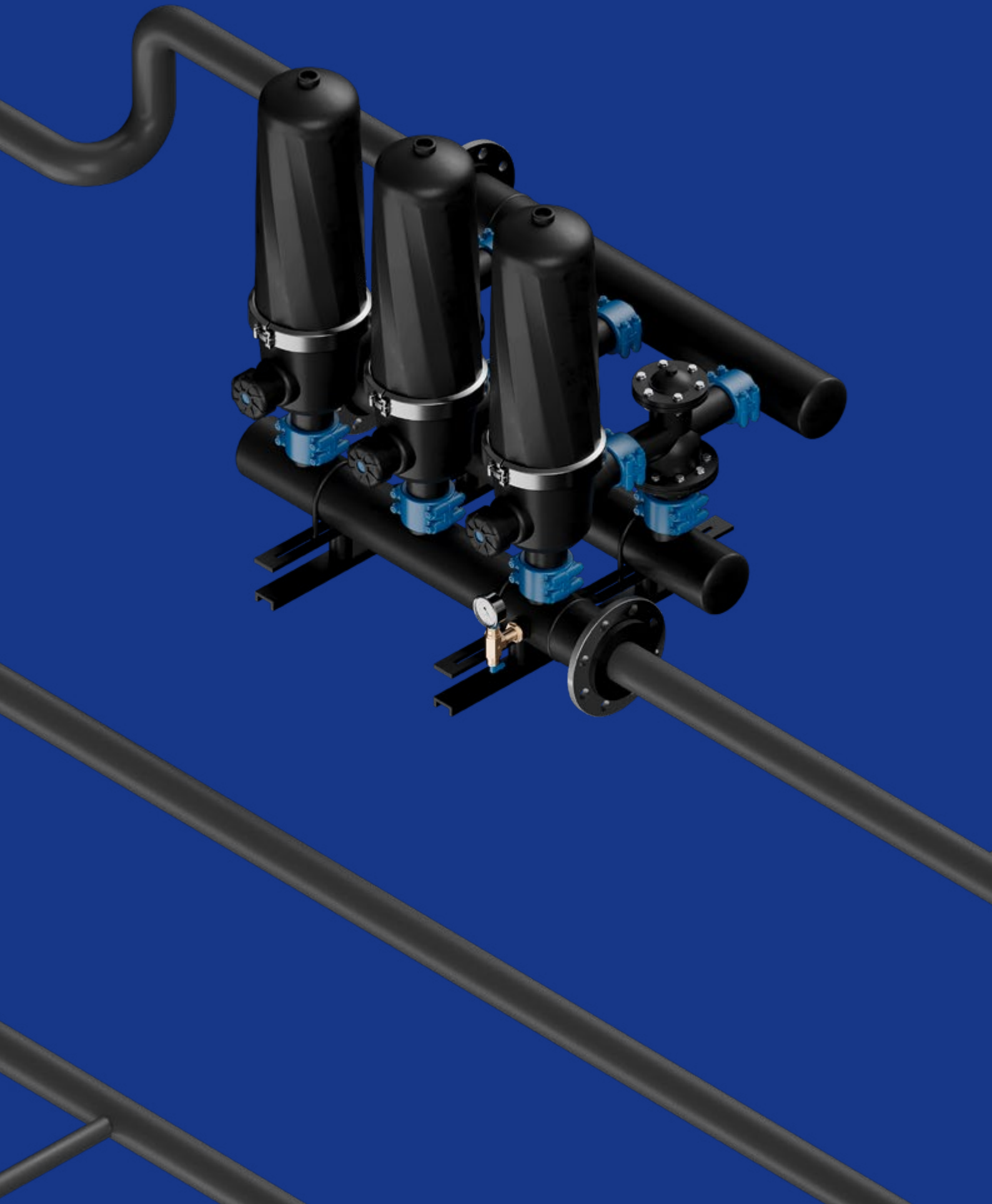

FILTRATION SYSTEMS

A suitable filtration system is crucial for plant health and clog-free cultivation seasons. Particularly precision irrigation equipment using drippers or micro emitters is susceptible to sand particles in the water supply. High concentrations of iron and manganese can also clog the system and require adequate filtering without removing plant nutrients. Once clogged, drip irrigation laterals may have to be entirely replaced to avoid greater damage and crop failure.

Considering your irrigation method, the system's size, water flow capacity, and water properties, we will choose the filtering, screen, disc, or separation equipment you need to keep maintenance to a minimum and system service life and plant health to a maximum.



SCREEN AND DISC FILTERS



Simple screen or disc filters are used in smaller projects with low flow capacity and where basic filtration is sufficient. Disc filters are often preferred as screens are sensitive to sand and will take damage over time.

TECHNICAL DETAILS

Standard filtration degrees

Screen/ Discs

- 530 micron (35 mesh)
- 200 micron (75 mesh)
- 130 micron (120 mesh)
- 100 micron (120 mesh)

APPLICATIONS

- Basic particle filtration
- Smaller, low flow-capacity irrigation

SAND FILTER



Diffuser or mushroom sand filters are usually used on water sourced from open water bodies such as lakes, ponds or water channels. Apart from sand particles, they also efficiently remove algae and microorganisms that multiply in wet and warm conditions and ultimately clog the irrigation system, affecting plant health.

TECHNICAL DETAILS

Maximum working pressure: 8 bar

Maximum working temperature: 60 °C

Maintenance: manual, automatic

APPLICATIONS

- Water containing organic and anorganic suspended particles

HYDROCYCLONE SAND SEPARATORS



Hydrocyclone sand separation devices are frequently used on water containing larger sand particles that would damage the filtration system. This is typically the case when the water is sourced from a well.

TECHNICAL DETAILS

Maximum working pressure: 8 bar

Maximum working temperature: 60 °C

APPLICATIONS

- Water containing larger sand particles

SELF-CLEANING FILTRATION SYSTEMS



All filters need to be regularly checked and cleaned. Multiple cartridge disc filtration systems can save you time as they self-clean without interrupting the irrigation process. If you have selected an electric valve system, the process is also automatic. Multiple cartridge disc filtration is typically applied in larger irrigation setups with higher flow capacities. If required by the water quality, they can be used in combination with a hydrocyclone or sand filter.

TECHNICAL DETAILS

Maximum working pressure: 10 bar

Maximum working temperature: 60 °C

Maintenance: semi-automatic, automatic

Standard filtration degrees

- 400 micron (40 mesh)
- 200 micron (75 mesh)
- 130 micron (120 mesh)
- 100 micron (120 mesh)

APPLICATIONS

- Water containing sand and particles
- Larger, higher flow-capacity irrigation
- Partially to fully automatic irrigation

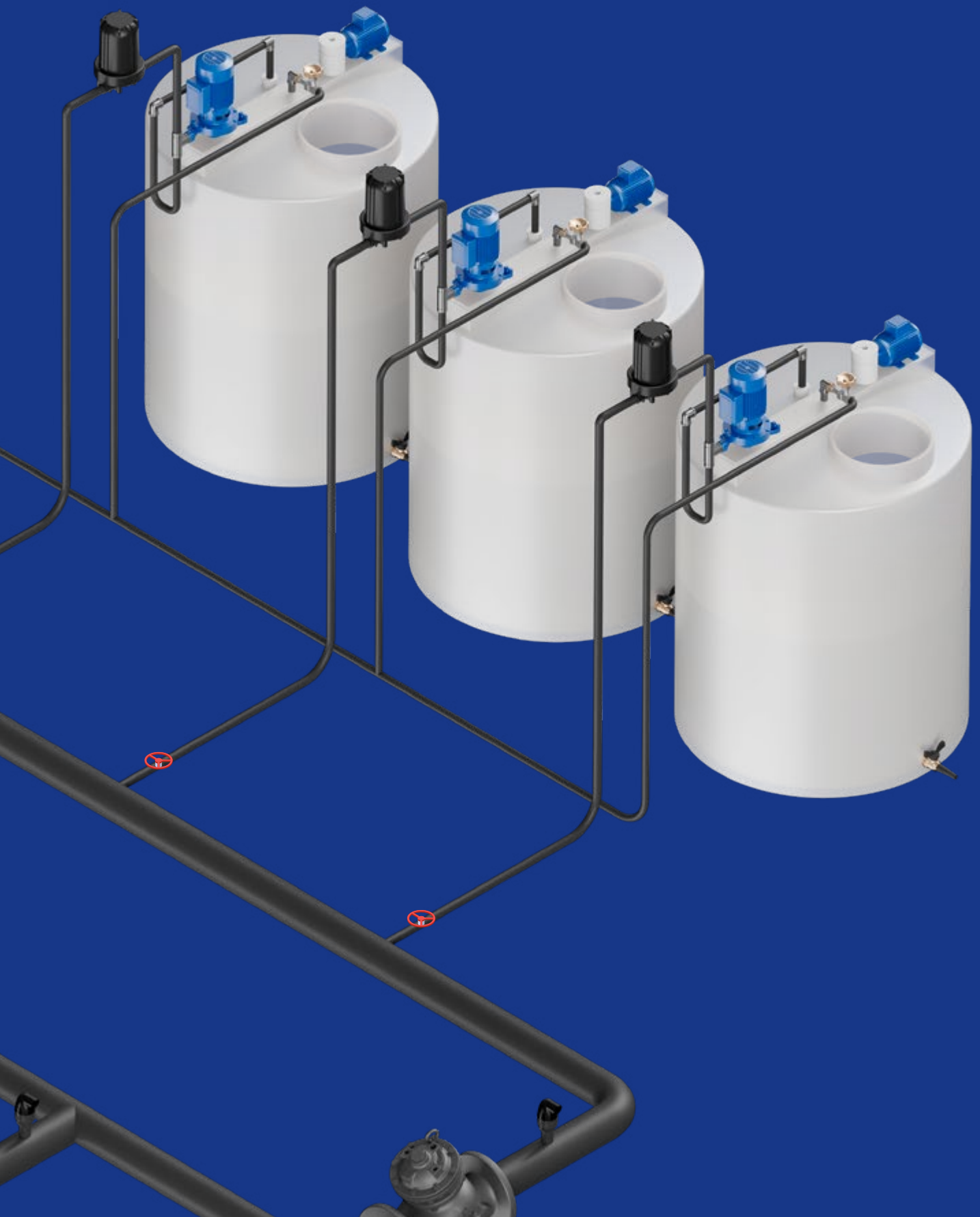

FERTIGATION SYSTEMS

Feeding water-soluble fertilizers through your drip irrigation system has many advantages. The right amount of fertilizer is brought directly to the plant's root zone. This means you do not only optimize plant health and growth while saving on fertilizer, but you are also protecting your soil. A further massive advantage is saving 100% of the work dedicated to fertilizing your fields.

The vast range of products available on the market can be overwhelming. Not only do types and functionalities vary from simple to almost scientific, but the price range is impressively large. We cannot repeat often enough that it is crucial to choose a system that suits your profile. With a wide choice of products at hand, we can design a fertigation system that matches the size of your irrigation project, crop needs and your personal preferences regarding technical complexity.



INJECTORS



Based on the principle of creating a vacuum through pressure difference, a simple automatic injector is ideal for smaller fertigation systems.

TECHNICAL DETAILS

Flow rate: 6 – 158 l/h

Pressure: 4.0 bar

Input: external threaded 3/4"

APPLICATIONS

- Smaller irrigation systems with low flow

MOTOR-DRIVEN DOSING PUMPS



Motor-driven dosing systems are usually applied in larger-scale projects. You can match various pump heads with a variety of motor sizes for a perfect fit.

TECHNICAL DETAILS

Flow rate: up to 1200 l/h

Pressure: up to 20 bar

Stroke rate: up to 116 strokes/minute

Power output: 0.18 – 0.75 kW

Power supply: 230/400V 50 Hz

APPLICATIONS

- Middle-sized to larger irrigation systems

PRECISION FERTIGATION SYSTEMS



Direct injection fertigation machines with one to several fertilizer channels are used in large-scale irrigation projects. Equipped with operation software, controller, electronic fertilizer flow meter, sensors and more, this type of fertigation system offers maximum control, automation and preciseness. Make sure to opt for a high-quality product that is easy to operate and does not exceed cultivation needs.

TECHNICAL DETAILS

Fertilizer channels: 1 to 8

Pressure: 4 bar

APPLICATIONS

- Large-scale irrigation systems
- Simultaneous fertigation of multiple crop types
- For dose sensitive crops and cultivation methods
- E.g., hydroponics, greenhouses

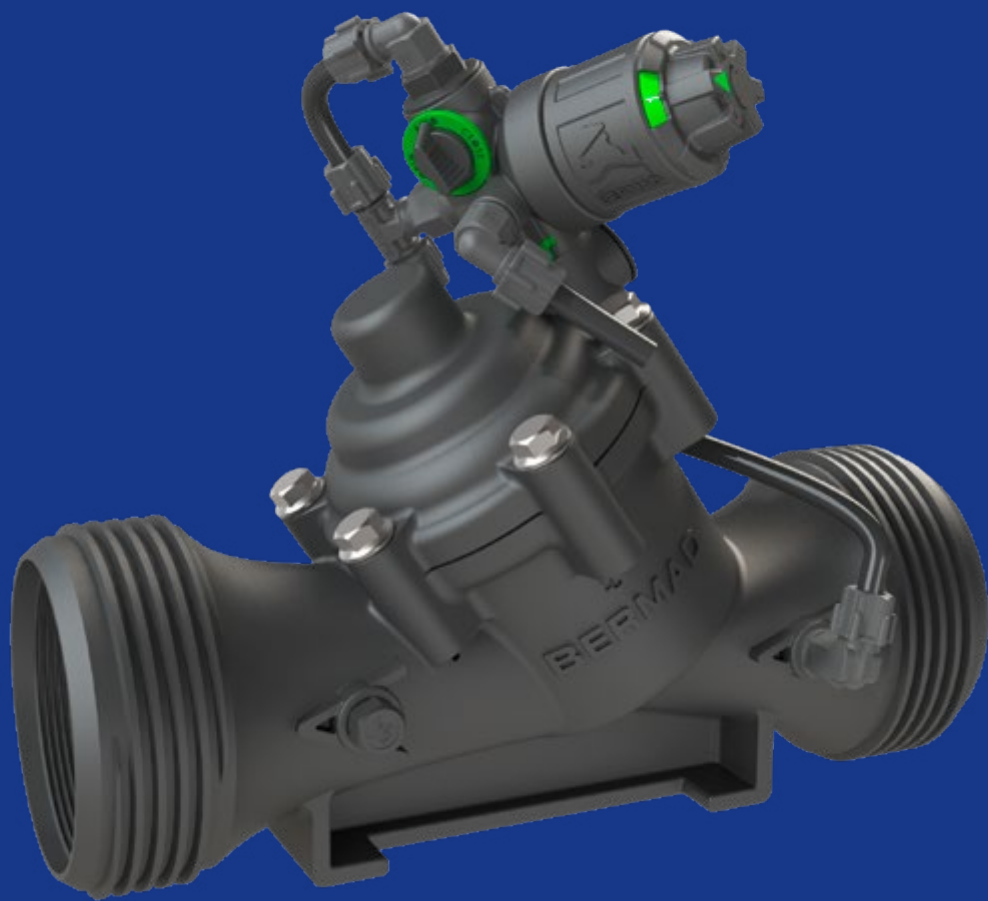

AUTOMATIC CONTROL VALVES

Choosing the right hydraulic valve system ensures optimal hydraulics and ideal pressure in every part of your irrigation system at minimal running costs. Apart from the standard on-off function, there are numerous control features available. You can, for instance, achieve various pressures within a combined irrigation system and control the pressure starting up the pumps.

Whether you choose a simple valve system or a more complex one with multiple features and remote control, sound quality prevents damage to the system, such as through a water hammer. Also, make sure not to oversize your valves only to be „on the safe side“ – this will result in unnecessarily higher running costs.

APPLICATIONS

- Pressure reduction
- Pressure maintenance
- Flow control
- Level control
- Solenoid control
- Combined control features



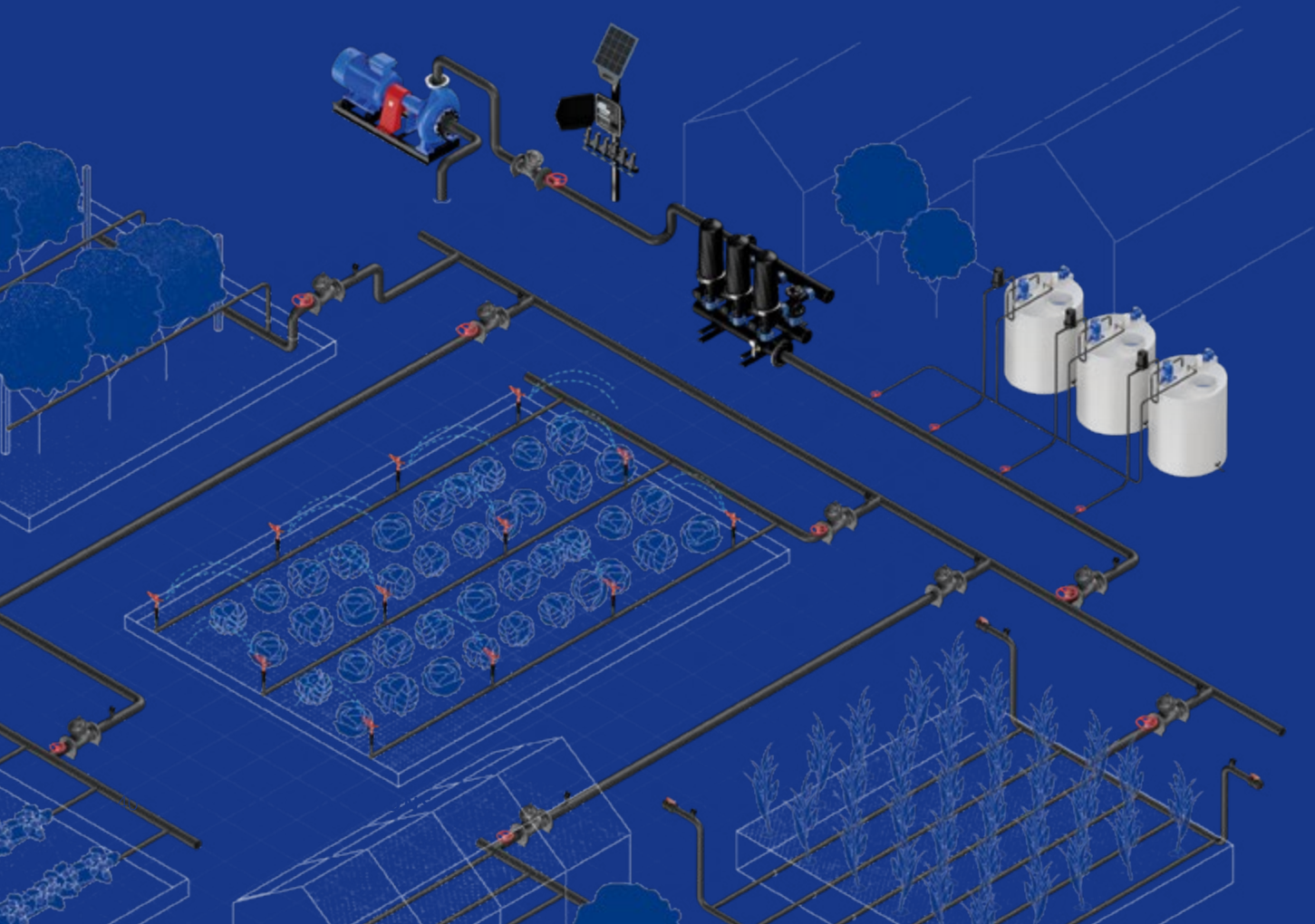
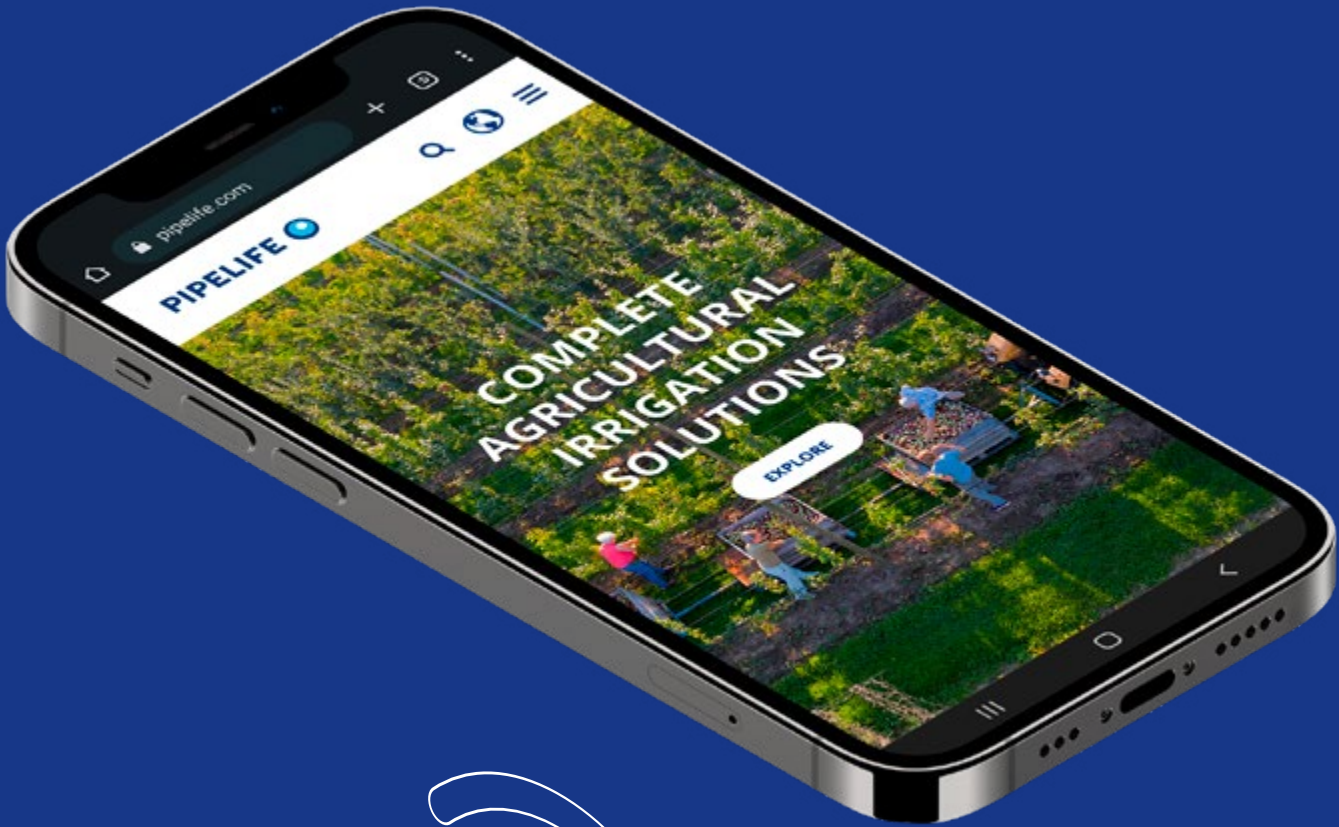

IRRIGATION CONTROLLERS

Irrigation control systems can be deployed to operate automatic irrigation equipment, sensors, etc., freeing up time and ensuring consistency. Controllers vary from the simple control of valves (opening, closing) to highly sophisticated systems that allow complete remote control over your entire plot.

Critical aspects for selecting a suitable control system are user-friendliness, compatibility and connectivity.

MINI CONTROLLERS



Small, entry-level controllers provide great simplicity for the user while having enough basic features to operate a three-step fertigation system and filter backflushing alongside opening and closing valves.

ADVANCED CONTROLLERS



To suit various applications, the setup of advanced controllers is flexible and involves programming. Via customizable computer and mobile interface, they offer complete remote control over main and multiple irrigation valves, fertilizer injectors, boosters and multiple filters.

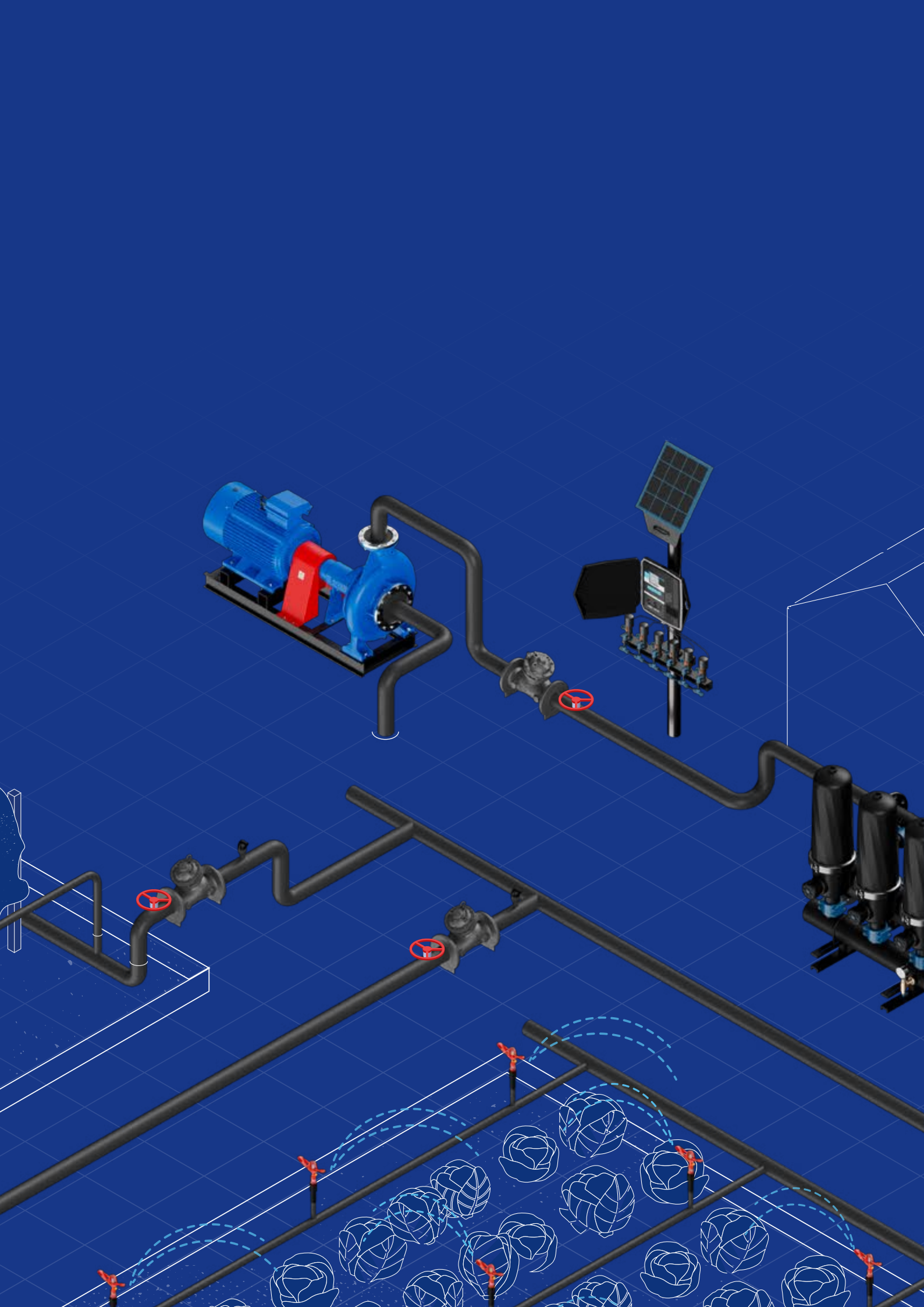

IRRIGATION PUMPS

The choice of irrigation pump depends on the type and scope of your irrigation system regarding minimal and maximal operating pressures. Site characteristics such as water source conditions and power supply (circuit, connections) must also be considered.

While undersized pumping systems will result in insufficient and uneven irrigation, oversized pumps cost more and increase running costs and can also damage the irrigation system over time.

There are various types of pumps available, each lending itself better to some application conditions than others. Our experts will provide you with a pumping system that best suits your budget and site requirements, regarding losses, system flow and operating pressures.





The contents and information contained in this brochure are intended for general marketing purposes only and shall not be relied upon by any person as complete or accurate. In particular, this brochure cannot replace proper expert advice on the characteristics of the products, their usage, suitability for any intended purpose, or the proper processing method. All contributions and illustrations in this brochure are subject to copyright. Unless explicitly otherwise stated, the repetition of content is not permitted. The use of photocopies from this brochure is for private and non-commercial use only. Any duplication or distribution for professional purposes is strictly forbidden. Non-Liability: PIPELIFE has established this brochure to the best of its knowledge. Pipelife cannot accept any liability suffered or incurred by any person resulting from or in connection with any reliance on the content of or the information contained in this brochure. This limitation applies to all loss or damage of any kind, including but not limited to direct or indirect damages, consequential or punitive damages, frustrated expenses, lost profit or loss of business.