

PRO INSPECTION CHAMBERS AND MANHOLES

PRO Sewer chamber system

Discover our full service portfolio online.

PIPELIFE 
always part of your life

TABLE OF CONTENTS

1	General information	5
2	Standards, approvals, certificates	6
3	Symbols of raw materials used in the production of chambers	6
4	Labelling of the chambers	7
5	Intended use	7
6	Scope and conditions of use	7
7	Properties of PP-B sewer chambers	8
8	Production technology	9
9	Chambers installation depth	9
10	Cleaning the sewer pipes	10
11	CCTV camera inspection	12
12	Advantages of sewer chambers	12

13	Technical characteristics of the chambers	13
14	Physical, mechanical and practical properties of the chambers	14
15	PRO 200, PRO 315, PRO 400, PRO 425 inspection chambers	14
16	Examples of structural solutions and applications of chambers	19
17	Technical guidelines	26
18	Installation of PRO 200, PRO 315, PRO 400, PRO 425 chambers	32
19	PRO 630, PRO 800, PRO 1000 chambers	40
20	Installation of sewer chambers	43
21	Installation instruction	54
22	Product range	57

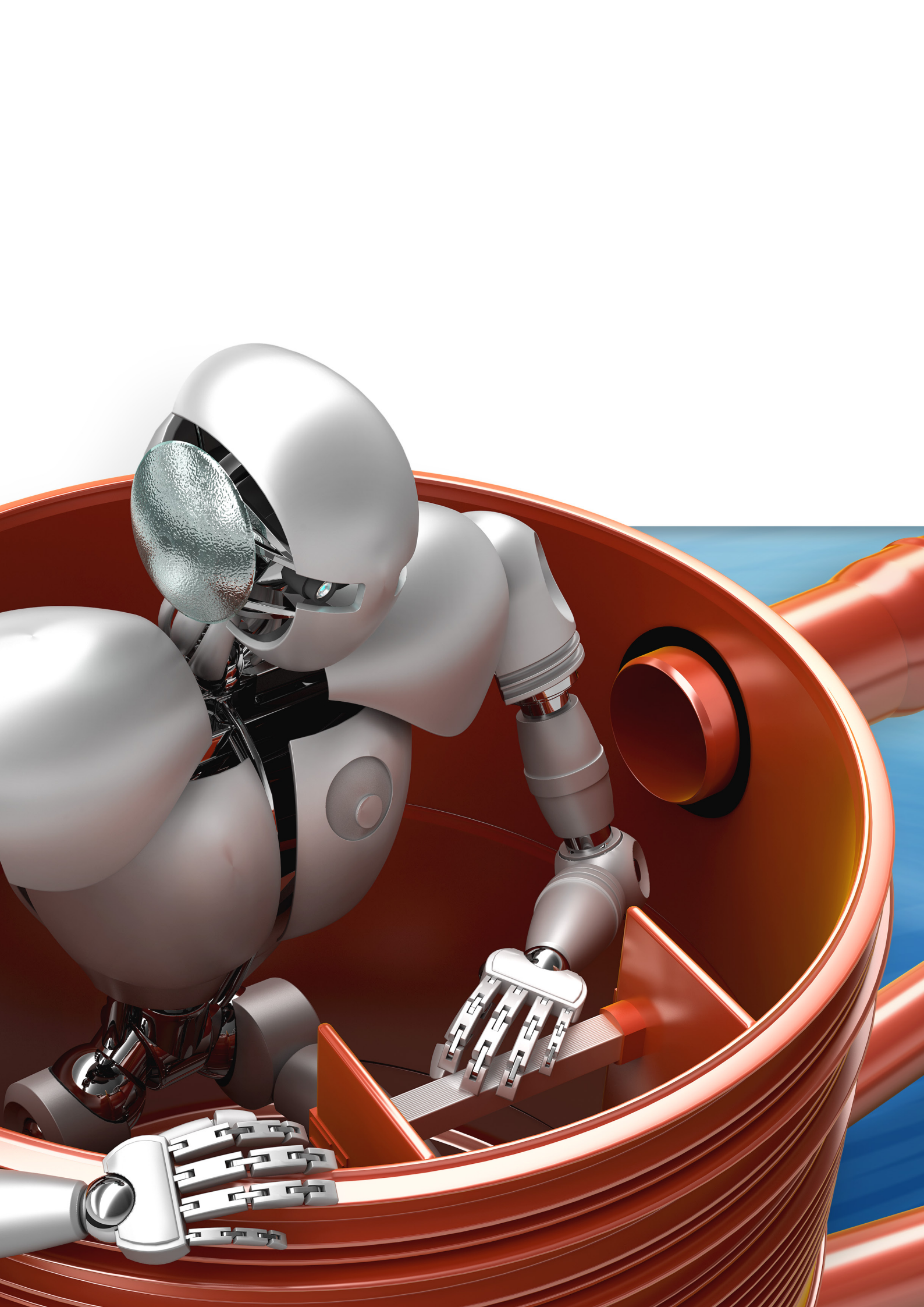

1. GENERAL INFORMATION

1.1. Introduction

Pipelife was one of the first companies on the European market to commence (in the early 1990s) the production of PP-B polypropylene sewer chambers for gravity drainage of household and industrial sewage and storm water. Chambers are essential elements of sewer systems. They provide access to pipes made of PVC-U thermoplastic smooth wall pipes or PP-B structural polypropylene pipes. They also enable the performance of necessary maintenance.

It should be stressed that Pipelife manufactures PVC-U sewage pipes with Sewer-Lock gaskets, providing tightness also under conditions of positive pressure up to 0.50 bar (5m water column) and negative pressure down to -0.60 bar (6 m water column). The PVC-U Pipelife pipes with Sewer-Lock gaskets retain extraordinary tightness against negative pressure of -0.60 bar, which is 200% higher than the standard one, at the angular deflection of the joint up to 6 degrees (higher by as much as 300%).

Pipelife's long-term experience in developing plastic sanitary and storm sewer systems has resulted in the production of a full range of sewer chambers. Pipelife aims at a maximum unification of its products, so that the same elements of the system could be applied in various systems, e.g. in water supply, sanitary and storm sewer, drainage systems, etc. Tests in pilot-plant scale, as well as performance tests carried out in diverse climate and ground conditions, confirmed high durability and good functional properties of the new solutions.

Pipelife offers inspection chambers from PRO 200 to PRO 630, used for inspection from the ground level, as well as PRO 800 and PRO

1000 mm manhole chambers, with a possibility to descend into the chamber, for inspection, maintenance and possibly cleaning of the sewer.

Technological progress related to the utilization of sewer systems, including especially the insertion of hydraulic equipment for cleaning the sewers, as well as CCTV surveillance, enable maintenance operations from the ground level. This helps to avoid compromising the health of employees who would otherwise have to work inside the chambers, and whose work has now become easier and safer.

The range of sewer chambers offered by Pipelife includes:

- PP-B inspection sewer chamber system: PRO 200, PRO 315, PRO 400, PRO 425, PRO 630
- PP-B manhole sewer chamber system: PRO 800, PRO 1000

It should be emphasized that the EN 476 standard accepts manhole chambers with the nominal inner diameter DN/ID 800 mm and the max. depth of 3 m, for occasional entry by a person equipped with harness, to monitor the cleaning, inspection and test equipment. The working height of the chamber should not be lower than 2 m. The height of 1.8 m is acceptable if required by the sewer depth and the landform.

All Pipelife chambers are made of PP-B polypropylene – a material of very high strength and performance parameters. A uniform system of PP-B chambers, fittings, and structural riser pipes, ensures meeting the same requirements and guarantees top-level, proper and long-term use.

It should also be pointed out that the offered products are made in a stable high pressure and low pressure injection moulding technology.

Note:

Plastic chambers from Pipelife have successfully been used for decades in very harsh conditions in Scandinavia, as well as in Germany, the Netherlands, and other countries.



2. STANDARDS, APPROVALS, CERTIFICATES

EN 13598-2:2016-09

Plastic pipelines for underground, non-pressurized storm water and sanitary sewer systems – Unplasticized poly(vinyl chloride) (PVC-U), polypropylene (PP) and polyethylene (PE) – Part 2: Specification of inspection and manhole chambers.

EN 13598-1:2011

Plastic pipelines for underground, non-pressurized storm water and sanitary sewer systems – Unplasticized poly(vinyl chloride) (PVC-U), polypropylene (PP) and polyethylene (PE) – Part 1: Technical specifications of auxiliary fittings, along with shallow inspection chambers.

AT-15-8235/2014 ITB

Pipelife inspection sewer chambers made from thermoplastic elements

AT/2009-03-1717/1 IBDiM

Pipelife system polypropylene (PP) sewer chambers: PRO 630, PRO 800 and PRO 1000

AT/07-2014-0181-01 IK

Polypropylene (PP) water drainage chambers: PRO 630, PRO 800 and PRO 1000

Technical Opinion of GIG (Central Mining Institute) no. 41/17

on PRO 315, PRO 400 and PRO 425 chambers, admitting the chambers to be used with a structural riser pipe or a smooth pipe with the stiffness $SN \geq 4$ in the areas of mining damage, cat. I to IV, and with a structural riser pipe with the stiffness $SN \geq 2$, for category I to III.

Technical Opinion of GIG (Central Mining Institute)

on PRO 630 chambers, admitting the chambers to be used with a structural riser pipe with the stiffness $SN 8 \text{ kN/m}^2$ in the areas of mining damage, category I to IV, and with a structural riser pipe with the stiffness $SN 4 \text{ kN/m}^2$ in the areas of mining damage, category I to III.

Technical Opinion of GIG (Central Mining Institute) no. 37/15

on PRO 800 and PRO 1000 chambers, admitting them to be used in the

areas of mining damage, category I to IV

UC test report 11404.v01s WRc

Test of the chamber walls resistance to hydrodynamic pressure according to WIS 4-35-01.

MFPA C41.08.010

Certificate of MFPA Institute (Germany) for PRO 400, PRO 630 chambers.

MFPA C41.10.005

Certificate of MFPA Institute (Germany) for PRO 800, PRO 1000 chambers.

K 43622/03 KIWA

KOMO Certificate of KIWA Institute (the Netherlands) Kunststof putten voor rioolselsels for PRO 630, PRO 800, PRO 1000 chambers.

Z-42.1-410 DIBT

Deutsches Institut Für Bautechnik (Germany) Schachtsysteme mit den Bezeichnungen "PELIFE M800 und M1000" in den Nennweiten DN 800 und DN 1000 aus Polypropylen PP-B

5144 Insta Cert

Insta Cert Institute Certificate for PRO 600, PRO 800, PRO 1000 chambers

EN 476:2012

General requirements for elements used in storm water and sanitary sewer systems

prEN 15229

Plastic pipeline systems -- Pipelines for underground, non-pressurized storm water and sanitary sewer systems -- Functional requirements for plastic manholes and inspection chambers.

EN 681-1:2002/A3:2006

Elastomer gaskets – Material requirements for gaskets in water and drainage pipes – Part 1: Rubber

3. SYMBOLS OF RAW MATERIALS USED IN THE PRODUCTION OF CHAMBERS

Explanation of symbols of raw materials used in the production of pipes and gaskets

PP-B - polypropylene block copolymer

PVC-U - unplasticized poly(vinyl chloride)

SBR - styrene-butadiene rubber

LPIM - Low Pressure Injection Moulding

EPDM - Ethylene Propylene Diene Monomer rubber

4. LABELLING OF THE CHAMBERS

Labelling should comply with the document of reference and contain at least the following data:

• Manufacturer code and/or trademark	PIPELIFE
• Material	PP
• Riser pipes and stub pipes diameters	np. 400/200
• Date of manufacture	np. 2010-02-18
• Standard or technical approval no.	EN 13598-2; AT-15-8235/ 2014; AT/07-2014-0181-01
• Construction mark	

5. INTENDED USE

Polypropylene (PP) PRO manhole and inspection chambers from Pipelife are intended to be used in the following outdoor gravity systems:

- household sewage
- storm water
- combined sewage
- industrial*, e.g.
 - industrial sewer systems
 - chemical plants sewer systems
 - agricultural production plants sewer systems
- water drainage.

Chamber types:

- Straight-through, junction chambers
 - Chambers with a catchment tank
 - Cascade chambers
 - Anti-flooding chambers
 - Speed reducing chambers
 - Water meter chambers
 - Tanks in sewage pumping stations
- * In the industrial sewer system design, account should be taken of the resistance of plastics to the chemical substances stated in ISO/TR 10358 standard, and for gaskets – ISO/TR 7620.

In the industrial system designs, account should be taken of the requirements of standard EN ISO 15494.

PRO manhole chambers make it possible to carry out maintenance, inspection and test works directly in the sewer pipes. Inspection chambers are meant for conducting these works from the ground level, using the devices made for this purpose.

6. SCOPE AND CONDITIONS OF USE

The chamber systems from Pipelife can be used:

- Nationwide
- At a truck traffic load of SLW 40, SLW 60
- In any natural ground conditions, whereas in case of weakly-carrying soils, e.g. peat, sludge, loams, clays, it is necessary to design reinforced bases
- In places with the groundwater level up to 5 m water column
- For sewage with the temperature up to 60°C at continuous flow, and up to +95°C at short-term sewage discharge.
- For sewage with reaction in the range of pH 2 – pH 12, if the PP-B chambers and the gaskets have high resistance to the chemical agents listed in ISO/TR 10358 and ISO/TR 7620 standards.

- In the areas where mining damage is present, the chambers can be used as per the Technical Opinion issued by the Central Mining Institute (GIG) in Katowice.

The PRO chambers should be installed as stipulated by the technical design. The space around a chamber (0.5 m from the base and the riser pipe) should be made of soil admitted to be used in road construction, as stipulated in PN-S-02205. Earthworks should be performed in accordance with the principles contained in EN 1610. Soil should be compacted in layers, in a manner preventing excessive ovalization of the chamber.

PRO chambers installed in roadways or in other places exposed to dynamic loads (group 3 and 4 acc. to EN 124) should have a cast iron top, class C250 and D400, as per EN 124. On

the other hand, in the areas where road traffic is prohibited, group 1 and 2 should have A15 and B125 class tops, according to EN 124.

7. PROPERTIES OF PP-B SEWER CHAMBERS

Pipelife sewer chambers are made of PP-B thermoplastic material and meet high strength and utility requirements, thanks to which they can be applied in various water and ground conditions.

The chambers are resistant to household sewage, as well as to high and low temper-

atures, which ensures their broad scope of application. High strength and impact resistance of Pipelife PP-B chambers allow for their installation in winter conditions.

The chambers comply with stringent requirements, and the deformation resistance of their bases is maintained for minimum 50

years. The chambers are also resistant to the impact of ground water (5 m water column), and remain tight at the positive pressure of 0.5 bar and the negative pressure of -0.3 bar.

7.1. Material properties

1. Material	Polypropylene block copolymer PP-B
2. Short-term temperature resistance (up to 2 min.)	95-100°C
3. Long-term temperature resistance	60°C
4. Average abrasion resistance acc. to Darmstadt test	0.2 mm over a period of 50 years
5. Roughness coefficients: Colebrook-White (k), Hazen-Williams (C), Manning (M), after 20 years	k = 0.25, C = 150, M = 105
6. Chemical resistance, chemical corrosion, physical corrosion	Resistance as per ISO/TR 10358
7. Biological corrosion (lichens, algae and fungi)	Resistant
8. Additional protective coatings	Not required
9. Corrosive resistance to waters and sewage as per DIN 4030	Resistant to pH<4.5 (very high degree of corrosive impact on concrete)

7.2. Structure of products

1. Water tightness	Pressure 0.5 bar, negative pressure -0.3 bar, EN 1277
2. Nominal stiffness of chamber cores	SN 2, SN 4, SN 8 kN/m ² EN 14982
3. Base impact resistance fall from the height of 0.5 m in the temp. of 0±1°C	EN 12061
4. Base resistance to groundwater (up to 5 m of water column)	EN 13598-2, EN14830
5. Drain base deformation - vertical	< 5%
- horizontal	< 10%, as per EN 14830
6. Resistance of ladder steps to vertical load	2 kN EN 13101
7. Adjustment possibility	Cutting the elements (riser pipe or the body), telescope or reinforced concrete ring
8. Production process stability	High, low impact of external factors
9. Wall's resistance to hydrodynamic pressure	Pressure ≥ 250 bar (PRO 400 chambers), ≥ 280 bar (PRO 400 G3), as per WIS 4-35-01

7.3. Use

1. Uneven settlement or overload	Strain compensation, viscoelastic materials
2. Temperature fluctuations around 0°C	Resistance to temp. from 0°C to -20°C (EN 744)
3. Chamber base deformation resistance	Over 50 years, acc. to EN 13598-2, EN 14830
4. Material durability	Over 100 years

8. PRODUCTION TECHNOLOGY

The bases for PRO 200, PRO 315, PRO 400 and PRO 425 inspection chambers are made of PP-B polypropylene (block copolymer), in the high pressure injection moulding technology.

The special structure of the chamber base provides a possibility of modular connection with stub pipes with the width ranging from 110 mm (PRO 200, PRO 400) to 400 mm. This ensures universality of connections.

PRO 630 chambers are made of PP-B polypropylene in the high and low pressure injection moulding technology. PRO 800 and PRO 1000 chambers are made of PP-B polypropylene in the low pressure injection moulding technology.

Advantages of PRO 630, PRO 800 and PRO 1000 chambers related to low pressure injection moulding technology:

- The lowest internal strains in the product, having positive effect on long-term strength and durability of the chambers
- Very high measurement accuracy
- Production repeatability

Characteristics of low pressure injection moulding production process:

- Low injection pressure, approx. 600-900 times lower than in high pressure injection moulding
- Lower flow rate of the injected material
- Lower softening point
- Possibility to manufacture large-size products
- Mottled colour of the products
- Lower strains in injected products, positive impact on material properties

Pipelife uses state-of-the-art production technologies and know-how, ensuring high quality of the products.

A characteristic trait of the chambers is a mottled colour, related to plasticisation of the raw material and its slower flow, at low injection pressure.

PRO 200, PRO 315, PRO 400, PRO 425 chambers, made in the high pressure injection moulding technology, are also characterized by very high process stability, measurement accuracy and production repeatability.

9. CHAMBERS INSTALLATION DEPTH

Sewer chambers can normally be installed at a depth from 1.0 m to 6.0 m, at the compaction of sandy soil of min. 90% in modified Proctor compaction tests in green areas, and 95% in modified Proctor compaction tests in a road, as well as with all the installation works performed under supervision, on a stone-free ground base. Detailed information on the maximum depth can be found on the chamber base or on its label. In the chamber installation zone, soil should be compacted, and the soil used for compaction should be selected according to the guidelines set out in point 17.4 Excavation backfilling. According to EN 13598-2, the maximum installation depth for the chambers should be 6.0 m. Minimum hollow size will depend on the chamber base height, the applied top and the expected load.

According to EN 13598-2 for chambers in-

stalled at a depth down to 6 m in heavy traffic areas, the nominal stiffness of the riser should be minimum SN 2. Pipelife chambers comply with these requirements and may be installed at greater depths.

Inspection and manhole chambers from Pipelife have numerous advantages, enabling installation in diverse ground and water conditions, and at static and dynamic pressure.

Advantages of Pipelife chambers influencing their strength and permissible installation depth:

- properly ribbed structure of the base, ensuring high resistance to ground and groundwater loads (up to 5 m of water column), as per EN 13598-2 and EN 14830
- ribbed structure of PRO 800, PRO 1000 chamber bodies

- corrugated PP-B structural riser pipes with the diameters of 400 mm with the stiffness SN 8 kN/m² (DW pipes) and 630 mm with the stiffness SN 5 kN/m² (DW pipes)
- the PRO 630, 800 and 1000 chamber bases have a double bottom, which increases their strength and, if the groundwater is present, eliminates its impact on the bottom of the chamber base
- telescopic tops, class A15 to D400, acc. to EN 24 or tops made from reinforced concrete cones and sewer manholes eliminate transfer of load from road traffic to the chamber bottom.

Symbols of riser pipes:

DW – double wall structural pipe

SW – single wall structural pipe

Pipelife has tested the deformation resistance (also referred to as structural integrity) of the PRO 315, PRO 400, PRO 425, PRO 630, PRO 800 and PRO 1000 mm chamber bases, according to EN 13598-2 and EN 14830.

Pipelife chambers are resistant to loads in the presence of groundwater at the level of 5 m (with negative pressure of 0.5 bar). In the long-term test of the invert channel base at the groundwater level of 5 m of water column; the vertical deflection of the PRO 800 mm chamber base is 0.03% (0.1 mm) and the

horizontal one is 1.49%. The acceptable vertical deflection of the chamber base, according to PN-EN 13598-2 and PN-EN 14830, is 5%, and the horizontal one is 10%.

It should be noted that in the case of PRO 800 and PRO 1000 chambers, in soils with high level of groundwater reaching above 1 m from the base bottom, it is recommended to use appropriate means of protection for the chamber (e.g. concreting).

Note:

Pipelife chamber base deformation after 50 years of use, in the presence of ground water at the level of 5 m of water column, is much lower than admitted by the standards, ensuring long and proper operation of the system.

10. CLEANING THE SEWER PIPES

Pipelife inspection and manhole sewer chambers, as well as sewer pipes, provide a possibility of high pressure cleaning. PRO 200 straight-through inspection chambers have (at the passage from the riser pipe to a sewer pipe) a specially profiled arc, which enables an easy insertion of the cleaning equipment from the ground level.

Such chambers can be used at sewer joints with the diameters of 110, 160 and 200 mm.

The diameter of PRO 200, PRO 315, PRO 400, PRO 425 and PRO 630 inspection chambers provides access to the sewer's bottom and a possibility to insert the cleaning equipment.

The diameter of PRO 800 and PRO 1000 manhole chambers provides a possibility to descend to the base bottom using ladder steps, and also to insert the cleaning equipment and perform maintenance works.

Thermoplastic pipes should be cleaned taking account of EN 13476-1, EN 14654 and CEN/TR 14920 standards.

The materials for plastic pipes (PVC-U, PE and PP) with solid and structural walls are covered by an extensive laboratory test pro-

gramme. New plastic pipes, as well as pipes which had been used for several years, were subjected to the impact of water with the pressure of 120 bar, using 2.8 mm nozzles, for more than 50 cycles, without damaging the pipes. The tests and the general practice in Europe have shown that the 120 bar pressure is sufficient for all plastics. It removes any possible clogging that may appear during use, and dirt is discharged to chambers together with plenty of water.

The independent rinsing tests results have proven that big quantity of slightly pressurized water is a much more effective way to remove obstructions and clean the pipes completely from the accumulated sediments, as well as to conduct routine maintenance activities. This method employs large-diameter nozzles (typically, with the diameter of 2.8 mm)

PRO 200 chamber base



Example of a sewer connection to a detached house

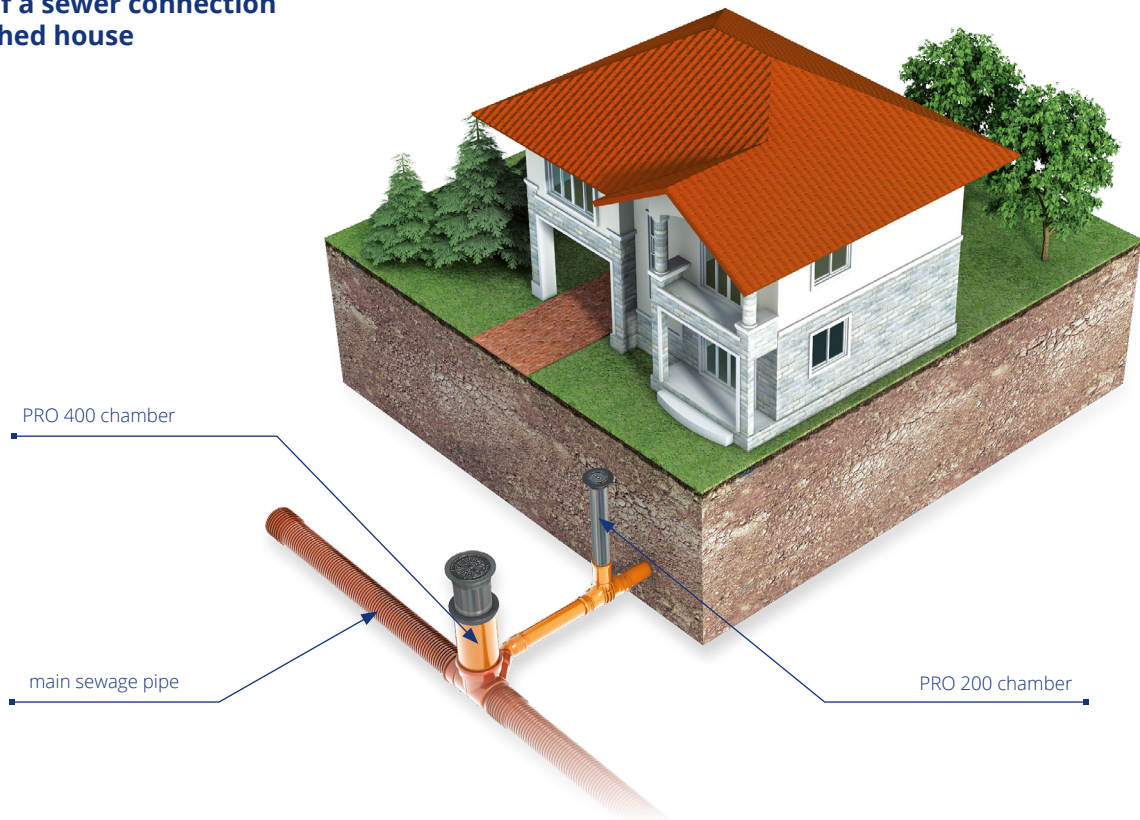

Recommended practical parameters for high pressure cleaning:

If soft waste and dirt is present, the pressure of 60 bars is sufficient. For significant quantity of accumulated waste material, a higher pressure (from 80 to 120 bars) may be necessary.

Rinsing pressure/flow rate:

1. Maximum pressure in the nozzle: 120 bars
2. Recommended waste rinsing rate: from 6 m/min to 12 m/min

Rinsing equipment:

1. Use rinsing equipment for low pressure/ large amount of water
2. Avoid using techniques involving high pressure/small amount of water
3. Select proper nozzle size for the equipment used and the size of the pipe cleaned.

Before cleaning, perform an inspection us-

ing a CCTV camera, to find the causes of blockage. This will help eliminate other causes, related to, e.g. damage to the pipe.

After the cleaning works are done, repeat the CCTV camera inspection and draw up a report on the completed maintenance works.

It is not recommended to clean using small, portable drilling devices, utilizing small amounts of water under high pressure (small-diameter 1 mm nozzles). Such a method of cleaning has the following disadvantages:

- Smaller active cleaning area and insufficient amount of water to discharge dirt to the chamber
- Possible formation of another blockage further toward the discharge direction
- Significantly higher risk of damage to the pipe wall, especially if the pipeline is not in good technical condition.

Note:

It is recommended to use large amount of water under low pressure to clean PP, PE, PVC-U thermoplastic pipes. This manner of cleaning has the following advantages:

- The pipe is cleaned on its entire circumference
- The cleaning element exerts a much stronger impact on the blockage.
- Larger amount of water flushes the dirt (waste) to the chamber
- The risk of damage to pipes is low

According to calculations, a 2.8 mm nozzle, under the pressure of 120 bars, generates on average, 5 times more energy than a 1 mm nozzle under the pressure of 340 bars.

11. CCTV CAMERA INSPECTION

In many European countries there are technical guidelines and standards which stipulate the frequency of sewer video inspections. PRO 315 inspection sewer chambers with PP-B ID 315 mm riser pipe, PRO 400 chambers with smooth wall PP-B or structural PP-B pipe with the outer diameter DN/OD 400 mm and 425 mm are suitable for inserting a video camera on a trolley.

Therefore, Pipelife, relying on its long-term experience, recommends the installation of

chambers with the riser pipe diameter DN/OD 400 mm, and to install chambers with a smaller riser pipe diameter only between chambers with DN 400 (or larger) risers, provided that the distance between the chambers with the riser diameter of DN 400 mm or larger is not greater than the test range of a mobile video camera.

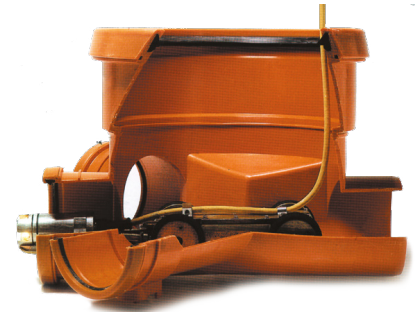

Insertion of a mobile video camera to the sewer through a PRO 400 mm chamber.

12. ADVANTAGES OF SEWER CHAMBERS

Pipelife sewer chambers and pipes meet rigorous requirements applying to outdoor sewer systems construction, and fulfil any needs and expectations of their users.

12.1. Broad range of products

Pipelife produces the systems for PRO 200, PRO 315, PRO 400, PRO 425, PRO 630 inspection chambers, as well as PRO 800 and PRO 1000 manhole chambers. The PRO chambers may be connected to complete sewer systems consisting of pipes, fittings and connectors (in the full range of diameters) for PVC-U 110-140 mm smooth wall pipes, as well as Pragma DN/OD 160-630 mm structural pipes. Pragma[®]ID DN/ID pipes can be joined to ID/OD smooth wall pipes, using adaptors.

12.2. Ease and precision of installation

Sewer chambers are characterized by low weight. Therefore, they can be installed and laid along with entire sets of pipes, in any conditions and without the need to use heavy construction equipment or to build access roads.

PVC-U pipes have gaskets which are factory-mounted in the sockets, while gaskets for connection with Pragma pipes are put on a pipe. Thanks to these solutions, the installation of chambers with pipes is quick, easy and precise, and the connections are tight and durable. The sockets of Pragma 160-500 mm pipes can be connected to PVC-U pipes by applying a gasket with a click ring, protecting the gasket against slipping out and providing strong, tight connection.

These solutions guarantee significant reduction in project costs, as the installation time becomes shorter.

12.3. Structural strength

Pipelife sewer chambers meet the requirements of EN 13598-2 and EN 476 standards; they are also characterized by appropriate structural strength against static loads (from the backfilling soil), dynamic loads (from road traffic), and the pressure from groundwater up to 5 m of water column. The chambers should be installed with observance of the requirements regarding proper foundation, arrangement and gravel pack, according to EN 1610, adapting the technology to the ground and water conditions and the expected load.

12.4. High resistance

Pipelife sewer systems are characterized by high resistance, both to the impact of chemical agents in the flowing medium, as well to external elements.

In particular, they prove to be resistant to:

- Discharge, general acidic, sulphate, magnesium, and carbonic acid corrosion
- Long-term impact of acidic and alkaline ground and water environment
- Chemical impact of discharged sewage
- Abrasion due to the impact of strongly silted and contaminated waters, including the impact of sand.

Sulphate corrosion

- The formed chemical compounds have larger volume and therefore impose increased strain in the pores, causing cracks in the concrete
- $\text{Ca}^{2+} + \text{SO}_4^{2-} \rightarrow \text{CaSO}_4$
- $\text{CaSO}_4 = 2\text{H}_2\text{O}$ (gypsum)
- The impact of sulphates on concrete leads to the formation of gypsum and Candlot's salt

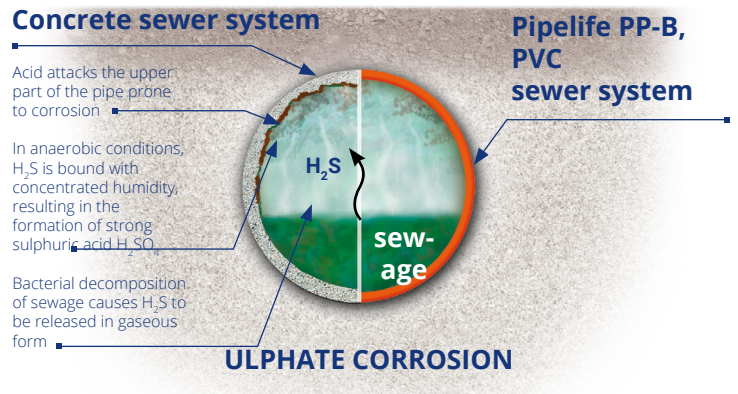

Magnesium corrosion

- The Mg²⁺ magnesium ions found in water, as well as magnesium salts found, e.g. in sea water, evoke the formation of calcium salts (CaSO₄, CaCl₂)
- $\text{MgSO}_4 + \text{Ca}(\text{OH})_2 = \text{CaSO}_4 + \text{Mg}(\text{OH})_2 \downarrow$
- $\text{MgCl}_2 + \text{Ca}(\text{OH})_2 = \text{CaCl}_2 + \text{Mg}(\text{OH})_2 \downarrow$
- Calcium salts can be washed out by water. CaSO₄ calcium sulphate can form gypsum and Candlot's salt
- As a result of transformation of the calcium hydroxide Ca(OH)₂ into magnesium hydroxide Mg(OH)₂, the concrete's alkalinity decreases, its strength deteriorates, and cracks and scratches appear.

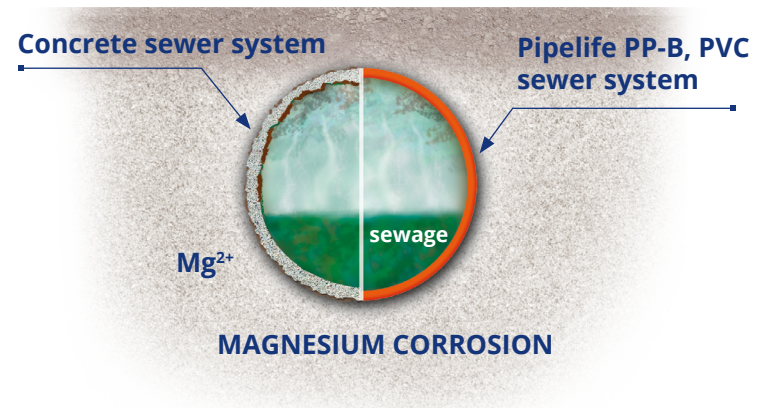

General acidic corrosion

- In acidic waters, with pH < 6.5, especially pH < 4.5, calcium hydroxide Ca(OH)₂ is leached out from concrete, due to chemical reactions with acids
- Easily soluble salts CaCl₂, Ca(NO₃)₂, Ca(HCO₃)₂, AlCl₃, Al(NO₃)₃ form – these salts are easily washed out by water
- Increasing concrete porosity leads to increased corrosion

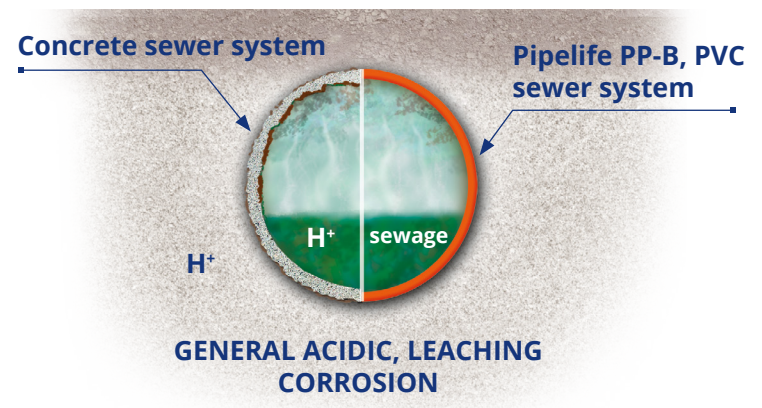

Carbonic acid corrosion

- The impact of aggressive carbon dioxide CO₂ causes chemical and physical leaching of calcium hydroxide Ca(OH)₂
- $\text{CO}_2 + \text{Ca}(\text{OH})_2 \rightarrow \text{CaCO}_3 + \text{H}_2\text{O}$
- $\text{Ca}(\text{OH})_2 + 2\text{CO}_2 \rightarrow \text{Ca}(\text{HCO}_3)_2$
- H₂CO₃ carbonic acid causes dissolution of the surface layer of concrete and washing out of Ca(OH)₂
- Strength deterioration leads to the formation of crack and scratches

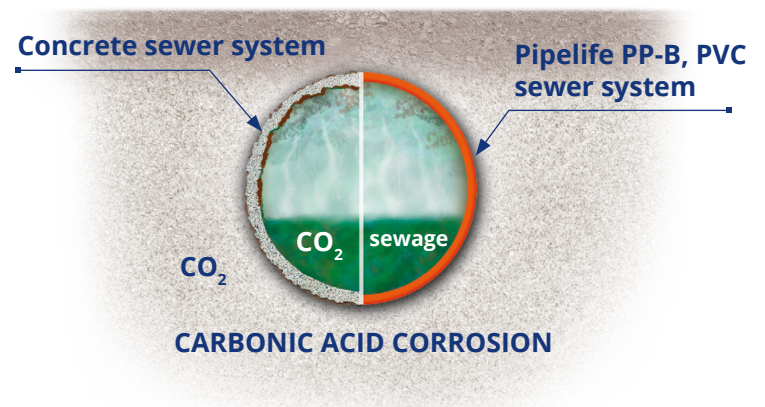

Chambers made of PP-B polypropylene are resistant, in a broad spectrum of pH < 4.5 acc. to DIN 4030, to corrosion caused, among others, by the impact of municipal sewage, as well as rainwater, surface and ground water.

Sewer chambers used in the sanitary and combined sewer systems should meet the requirements of increased resistance to sewage and hydrogen sulphide. It is of particular importance if the system is designed for an area with low inclinations, where periodical rotting of sediments may occur. Discharging, acidic and swelling corrosions are especially harmful to concrete and reinforced concrete materials.

Alkaline reaction of concrete, resulting from the presence of calcium hydroxide $\text{Ca}(\text{OH})_2$, causes this material to corrode in acidic environment. Due to quite high solubility of calcium hydroxide in water, water environment has a corrosive impact on concrete whose main components include Portland cement. Apart from acting as a solvent, water has a significant impact on the chemical weathering process, especially if it contains dissolved CO_2 , salts and acids.

Typically, concrete pores diameter (approx. 70% of macro- and 30% of micro-pores) is larger than the diameter of water molecules. This, however, does not prevent penetration into concrete of smaller molecules, including molecules of acids, oils, etc.

If water or sewage has pH of 6.5-5.5, then, according to DIN 4030 standard, it has low, at pH 5.5-4.5 – strong, and at pH < 4.5 – very strong corrosive impact on concrete. The content of CO_2 , NH_4^+ , Mg^{2+} , SO_4^{2-} is also essential.

Therefore, when designing sewer systems using traditional materials (e.g. concrete), the designer must be provided with precise data regarding the corrosion aggressiveness of water and sewage.

As required by EN 476 standard, when designing sewer systems, it is necessary to use materials which will not reduce the system's durability.

12.5. Excellent hydraulic parameters

Polypropylene hydraulic chambers made by Pipelife have excellent hydraulic parameters; they are resistant to sedimentation on the inner surface of the pipe. Very smooth walls prevent the development of microorganisms and bacteria on their surface. The chambers conform to the requirements of EN 476 standard. PRO 400 chambers have also been tested in the SP institute, in accordance with the DS 2379 standard (Denmark), and they meet the requirements of this standard. However, the requirements of the completed tests apply rather to sewer inlets, than to sewer chambers.

Very low absolute roughness coefficient of thermoplastic pipes, especially after many years of use, provides the highest flow capacity, as opposed to pipes made of other materials, such as concrete or cast iron.

The roughness coefficients for plastics after 20 years of use are as follows:

- Colebrook-White $k = 0.25$
- Hazen-Williams $C = 150$
- Manning $M = 105$

The roughness coefficients for, e.g. concrete pipes, after 20 years of use, are as follows:

- $k = 2$
- $C = 90$
- $M = 60-65$

12.6. High quality and durability

In order to achieve the highest possible quality of products, Pipelife uses premium quality raw materials, state-of-the-art manufacturing technology, as well as special construction of gaskets characterized by very high chemical resistance and tightness.

The main raw material for the production of sewer chambers, as well as pipes and fittings, is PP-B polymer (block copolymer), owing its growing popularity to very good properties which qualify the material for versatile use. A sewer system made of a uniform material, with excellent parameters, guarantees long-term, failure-free use.

Pipelife sewer systems are durable, strong and tight. They do not require maintenance throughout their life span.

12.7. Possibility of connecting to systems made of other materials

The system of connecting fittings enables the installer to:

- connect chambers to PVC-U pipes and connect PVC-U sewer pipes to cast iron, stoneware or concrete pipes
- connect chambers to Pragma pipes, and connect Pragma structural sewer pipes to cast iron, stoneware or concrete pipes using adapters for Pragma pipes, that is a ring with a gasket (Pragma socket) or an adapter for a PVC-U socket (Pragma spigot)
- connect chambers to systems made of PE, PP-B (Pragma, Pragma+ID structural pipes), cast iron, concrete and stoneware
- connect pipes to concrete chambers
- make connections (as per user's requirements)

13. TECHNICAL CHARACTERISTICS OF THE CHAMBERS

DESCRIPTION	PRO 200	PRO 315	PRO 400	PRO 425	PRO 630	PRO 800	PRO 1000
Material	PP-B	PP-B	PP-B	PP-B	PP-B	PP-B	PP-B
Chamber type	inspection				manhole		
Inner diameter of the manhole [mm]	-	-	-	-	-	630	630
Elements of chambers	<ul style="list-style-type: none"> base PVC-U riser pipe telescope cone 	<ul style="list-style-type: none"> base PP-B riser pipe telescope cone cover 	<ul style="list-style-type: none"> base PP-B, PVC-U riser pipe telescope cone cover 	<ul style="list-style-type: none"> base PP-B riser pipe telescope cone cover 	<ul style="list-style-type: none"> base PP-B riser pipe telescope reinforced concrete ring 	<ul style="list-style-type: none"> base PP-B riser reduction reinforced concrete rings telescope 	<ul style="list-style-type: none"> base PP-B riser reduction reinforced concrete rings telescope
BASE							
Material	PP-B	PP-B	PP-B	PP-B	PP-B	PP-B	PP-B
Diameters of PVC-U sewer pipes [mm]	110-200	160-200	110-400	160-400	160-400	160-400	160-400
Diameters of Pragma PP-B sewer pipes [mm]	160-200 using adapters	160-200 using adapters	160-400 500-630	160-400	160-400	160-400	160-400
Diameters of Pragma-ID PP-B sewer pipes [mm]	using adapters	using adapters	using adapters 500-800	using adapters	using adapters	using adapters	using adapters
Base types	<ul style="list-style-type: none"> straight-through 0° 	<ul style="list-style-type: none"> straight-through 0° side junction 45° with one side branch 45° chamber bottom closing the riser pipe 	<ul style="list-style-type: none"> straight-through 0° junction 45°, 90° with one side branch 45° or 90° chamber bottom closing the riser pipe 	<ul style="list-style-type: none"> straight-through 0° connection 45°, 90° (straight-through channel ≥ 250) with one side branch 45° or 90° (straight-through channel ≥ 250) chamber bottom closing the riser pipe 	<ul style="list-style-type: none"> straight-through 0°, 45°, 90° connection 45°, 90° with one side branch 45° or 90° closed end cap for closing the riser pipe 	<ul style="list-style-type: none"> straight-through 0°, 45°, 90° connection 45°, 90° with one side branch 45° or 90° closed 	<ul style="list-style-type: none"> straight-through 0°, 45°, 90° connection 45°, 90° with one side branch 45° or 90° closed
Structure	single bottom		ribbed single bottom		double bottom		
Max. ground water level above the foundation [m]	3 m	5 m	5 m	5 m	5 m		
RISER							
Material	PP-B	PP-B	PP-B	PP-B	PP-B	PP-B	PP-B
Nominal diameter of the riser DN [mm]	200	315	400	425	630	800	1000
Outer diameter of the riser [mm]	200	352 SW	400 DW	474 SW	630	890	1090
Inner diameter of the riser dem [mm]	190	319 SW	350 DW 390 PVC-U	426 SW	546	800	1000
Height adjustment options:							
• cutting	riser may be cut at any length	SW riser may be cut in 5 cm intervals	DW riser may be cut in 3 cm intervals	SW riser may be cut in 7 cm intervals	DW riser may be cut in 5 cm intervals	riser may be cut in 10 or 20 cm intervals whereas reduction may be cut in 10 cm intervals	riser may be cut in 10 or 20 cm intervals whereas reduction may be cut in 10 cm intervals
• stepless adjustment	for the telescope or the cone	for the telescope or the cone	for the telescope or the cone	for the telescope or the cone	for the telescope every 25 cm	for the reinforced concrete ring	for the reinforced concrete ring
Riser nominal stiffness SN [kN/m ²]	4	4 SW 2 SW	12 for PVC-U pipe 8 for DW pipe 4 for PVC-U pipe 2 for PVC-U pipe	4 SW 2 SW	8 for DW pipe	>2 EN 14982	>2 EN 14982
TOP							
Top type	telescope T05M T20	telescope T05D, T30, B125, T40, D400; T05D, T30K, B125K, T40K, D400K	telescope T05D, T30, B125, T40, D400; T05D, T30K, B125K, T40K, D400K	telescope A15 B125, C250, D400; gully A15 B125, C250, D40; telescope T05D, T30, B125, T40, D400; gully T05D, T30K, B125K, T40K, D400K	PE telescope, reinforced concrete ring, cast iron manhole	reinforced concrete ring, cast iron manhole; PP telescope, reinforced concrete ring, cast iron manhole; reduction cone, ring with laddersteps, concrete cone, PP telescope with a flange, cast iron manhole	reinforced concrete ring, cast iron manhole; PP telescope, reinforced concrete ring, cast iron manhole; reduction cone, ring with laddersteps, concrete cone, PP telescope with a flange, cast iron manhole
Nominal diameter DN [mm]	160	315	315	400 315	600	600	600
Load classes:							
• covers	-	A15	A15	A15	-	-	-
• manholes	A15, D400	A15, B125, C250, D400	A15, B125, C250, D400	A15, B125, C250, D400	A15, B125, C250, D400	A15, B125, C250, D400	A15, B125, C250, D400

Symbols: DW – double wall structural pipe, SW – single wall structural pipe

14. PHYSICAL, MECHANICAL AND PRACTICAL PROPERTIES OF THE CHAMBERS

No.	Properties	Requirements	Test method
1.	Flexibility or mechanical strength of stub pipes	no delamination, cracks, scratches, leaks	EN 12256
2.	Chamber base impact resistance (tested by dropping onto hard surface): • temp. 0±1°C • height 0.5 m	no damage	EN 12061
3.	Resistance of ladder steps to vertical loads • load 2 kN	max. deformation under the load: 10 mm, after removing the load: 2 mm	EN 13101
4.	Impact of heating on the appearance of injection moulding products (furnace test) • test temp. 150±2°C	the depth of cracks should be smaller than 20% of the wall thickness	EN ISO 580 Method A
5.	Tightness of a chamber with stub pipes and connections with elastomer gaskets • test temp. 23±2°C • water pressure: 0.5 bar • negative pressure: from -0.3 bar to -0.27 bar	no leaks	EN 1277 Method 4 conditions B
6.	Nominal stiffness of chamber risers SN [kN/m ²] • PVC-U 200 pipe • PVC-U 400 pipe • PP-B DW (double wall) pipe, e.g. 400, 630 mm • PP-B SW (single wall) pipe, 315, 425 • PP-B 800, 1000 mm riser • PP-B PP DW (double wall) pipe DN/ID	min. SN 2 SN 2, SN 4, SN 8, SN 12 SN 4 SN 4, SN 8 (SN 10, SN 12, SN 16) SN 2, SN 4 SN 2 SN 8, SN 10, SN 12, SN 16	EN 14982

15. PRO 200, PRO 315, PRO 400, PRO 425 INSPECTION CHAMBERS

Most important features:

- Pipe with a structural wall (corrugated outside and smooth inside, or corrugated single wall pipe) with the nominal stiffness of SN 8 kN/m², 4 kN/m² or 2 kN/m²
- Riser pipe made of PP-B, which results in:
 - Significant reduction in pipe weight
 - Much higher resistance to impact
 - Much higher resistance to low and high temperature
 - Much higher chemical resistance as compared to PVC pipes
 - Increased strain compensation
- Extended chamber base socket
- Internal inclination of 2% in the flow direction
- Ribs stiffening the structure, additionally improving the conditions of foundation and ground compaction around the chamber base

PRO 200 chamber

The chamber consists of the following elements:

1. Polypropylene chamber base (PP-B) – straight-through, DN/OD 110-200 mm
2. PVC-U riser pipe DN/OD 200 mm
3. PVC-U telescopic smooth wall pipe with the outer diameter of 160 mm
4. Gasket (manchette) used at the connection of the riser pipe with the telescopic pipe, with the diameter DN 200/160 mm
5. Cast iron top with cover: T05M (A15), T20 (D400), acc. to EN 124.



PRO 315 chambers

The chamber consists of the following elements:

1. Polypropylene chamber base (PP-B)
2. Riser pipe made of PP-B DN/ID 315 mm (structural single wall pipe SW SN 4 kN/m² or SW SN 2 kN/m²)
3. PVC-U telescopic smooth wall pipe with the outer diameter of 315 mm

PRO 400 chambers

The chamber consists of the following elements:

1. Polypropylene chamber base (PP-B)
2. Riser pipe made of PVC-U DN/OD 400 mm, and of polypropylene PP-B DN/OD 400 mm (structural DW double wall pipe SN 8 kN/m²)
3. PVC-U telescopic smooth wall pipe with the outer diameter of 315 mm
4. Gasket (manchette) used at the connection of the riser pipe with the telescopic pipe, DN 400/315 mm diameter
5. Cast iron top with cover: T05D (A15), T30, B125 (B125), T40, D400 (D400) or a sewer gully T05K (A15), T30K, B125K (B125), T50K (C250), D400K (D400), according to EN 124.

PRO 425 chambers

The chamber consists of the following elements:

1. Polypropylene chamber base (PP-B)
2. Riser pipe made of PP-B DN/ID 425 mm (structural single wall pipe SW SN 4 kN/m² or SW SN 2 kN/m²)
3. 425 mm gasket to seal the connection of the riser pipe with the base, and 425 mm or 425/315 mm telescopic gasket
4. Telescope with a smooth wall PVC-U pipe, 400 mm and 315 mm
5. Cast iron top with a full cover and a gully (inlet) in classes A15, B125, C250, D400, acc. to EN 124

Types of chamber bases

- Straight-through base DN/OD 160-400 mm
- Junction base DN/OD 110-400 mm – junction base DN/OD 250-400 mm with one branch 45° or 90° DN/OD 160-400 mm
- Straight-through base for Pragma pipes DN/OD 500, 630 mm
- Junction base for Pragma pipes DN/OD 500, 630 mm with a side branch 45° or 90° DN/OD 160-400 mm
- Straight-through base for Pragma+ID pipes DN/ID 500-800 mm with a side branch 45° or 90° DN/OD 160-400 mm
- Junction base for Pragma+ID pipes DN/ID 500-800 mm with a side branch 45° or 90° DN/OD 160-400 mm

PRO 400 chamber base sockets to connect pipes with the diameters ranging from 160 mm to 400 mm have a universal structure, enabling direct connection with the Pragma or PVC-U structural pipe through a gasket and a snap ring.



PRO 200

PRO 315

PRO 400 with a PP Pragma riser pipe

PRO 400 with a PVC-U smooth wall riser pipe

PRO 425

Elements of chambers:

- 1 telescope
- 2 manchette gasket
- 3 PVC-U riser pipe
- 4 PP-B single wall riser pipe
- 5 PP-B double wall riser pipe
- 6 gasket
- 7 chamber base

15.1. Chamber bases

PRO 200, PRO 315, PRO 400, PRO 425 chamber bases by Pipelife are made of injection moulded polypropylene (PP-B). The base has a specially profiled bottom which, in combination with smooth surface, guarantees very good hydraulic performance.

The PRO 315, PRO 400 and PRO 425 bases have an internal 2% inclination. Their high hydraulic efficiency is also provided by appropriate construction of side branches. An accidental fall or impact will not cause any cracks or damage, even in low temperatures. The strength of chamber bases is verified in the impact resistance test, in which the bases are dropped onto a concrete surface from the height of 0.5 m, in the temperature of $0\pm 1^{\circ}\text{C}$, as per EN 12061. At the same time, polypropylene is highly resistant to the impact of high temperatures.

These features significantly increase the functional advantages of the PP-B bases.

The bases for smooth pipes are factory-equipped with special gaskets made of refined synthetic rubber. In bases for PP-B structural pipes, the gasket is embedded on the pipe. Such a method of connecting ensures positive results of tightness tests,

requiring the maintenance of a 5 m water column pressure. This means that the chambers protect the sewer system from infiltration of groundwater to the sewers, as well as from exfiltration of sewage to the ground.

Pipelife system chamber bases are offered as:

- Straight-through bases
- Junction bases
- Catchment bases, made on the basis of PP-B structural pipe

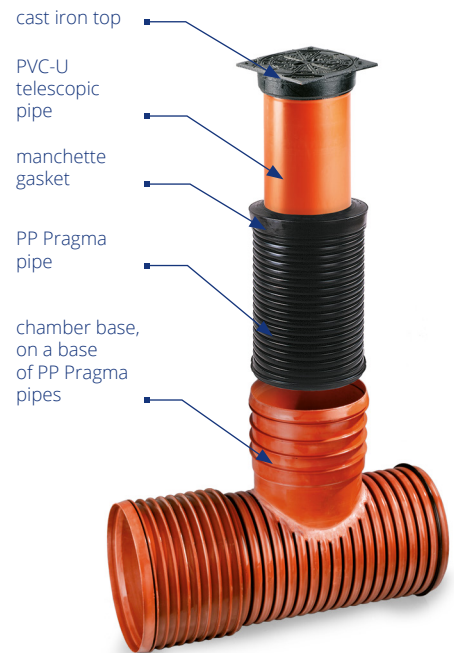

Pipelife chamber made on a base of a PP-B Pragma or Pragma*ID pipe

Note:

The manner PP-B bases are manufactured gives them extraordinary mechanical resistance, also in low temperatures.

15.2. Riser pipe

Riser pipes may be cut to an appropriate size on-site, using a carpenter's saw or a jigsaw. The surface of the cut should always be deburred.

In sewer and drainage chambers without a catchment tank, whose top part reaches the ground surface, the riser pipe is an element connecting the base with the telescopic pipe.

In sewer chambers with catchment tanks and in many solutions for underground drainage chambers, the riser pipe is the core element of the chamber's structure. Depending on the used chamber base, the riser pipe is a smooth sewer pipe without a socket made of PVC-U, DN/OD 200 (PRO 200), PP ID 315 (PRO 315), PVC-U 400 mm (PRO 400) or PP ID 425 (PRO 425), PP-B DW

double wall structural pipe with the diameter DN/OD 400 mm (PRO 400). Riser pipes are offered in standard lengths of 2 and 6 m.



Riser pipe ID 315 mm
PP-B SN 4 kN/m²
SN 2 kN/m²



Riser pipe 400 mm
PVC-U SN 4 kN/m²

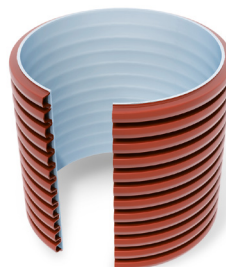

Riser pipe 400 mm
PP-B DW SN 8 kN/m²



Riser pipe ID 425 mm
PP-B SN 4 kN/m²
SN 2 kN/m²

15.3. Telescopic gaskets for riser pipes

Every telescope is equipped with a special, profiled ring gasket, enabling a flexible connection between the telescope and the riser pipe. There are three types of telescopic gaskets: for a double wall (DW) structural pipe, for a single wall (SW) structural pipe, and for a PVC-U structural pipe.

15.4. Telescopic chamber tops

Pipelife manufactures telescopic chamber tops: T20, T30, T30K, T40, T50K, in which the PVC-U telescopic pipe with the diameter of 160, 315 or 425 mm is permanently integrated with the cast iron manhole body. The telescopic pipe is inside the cast iron body, thanks to which it is protected, e.g. against hot bituminous mass. The telescopic pipe is adapted to the internal shape of the body.

Telescopic tops by Pipelife are manufactured in accordance with EN 124 standard and are labelled, on the cast iron frame and the cover, as follows:

- Manhole type, e.g. T40 or D400
- Manhole carrying capacity class, e.g. D400
- EN 124 standard
- Pipelife logo
- Manufacturer's mark

There are the following types of inte-

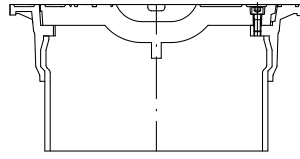

Telescope integrated with the manhole body

grated cast iron manholes:

- T05M** cast iron rectangular manhole with a full cover, class A15 kN (for chambers DN 200),
- T20** cast iron round manhole with a full cover, class D400 kN (for chambers DN 200 mm),
- T05D** cast iron square manhole with a full cover, class A15 kN,
- T30** cast iron square manhole with a full cover, class B125 kN,
- T30K** cast iron square manhole with a gully, class B125 kN,
- T50K** cast iron rectangular manhole with a gully, class C250 kN,
- T40** cast iron round manhole with a full cover, class D400 kN.

The offer also includes standard telescopes in which a telescopic pipe is mechanically bolted to the manhole body.

There are the following types of standard cast iron manholes:

- T05DK** cast iron square manhole with an inlet, class A15 kN,
- B125** cast iron square manhole with a full cover, class B125 kN,
- B125K** cast iron square manhole with a full cover, class B125 kN,
- D400** cast iron square manhole with a full cover, class D400 kN,
- D400K** cast iron square manhole with an inlet, class D400 kN.

Any strains and micromovements generated in the ground and related, first and foremost, to the dynamic load from road traffic and to seasonal temperature changes, are compensated in the telescope's ring gasket.

This way, the telescopic top of the chambers eliminates the transfer of any loads to the chamber base, ensuring long-term, failure-free use.

Chambers with telescopes must always be arranged in such a way that the manhole can be embedded in a hardened pavement. The road traffic load is transferred through the manhole to the base course whose carrying capacity is adequate to the load.

In asphalt pavement, special attention should be paid to correct preparation of the base course and asphalt layers coming into direct contact with the telescopic pipe and the cast iron manhole frame.

In pavements hardened with fine concrete or stone elements, e.g. sett, it is possible to install a cast iron manhole on a poured slab made of C25/30 (former B30) class concrete, and on a base course made of cement-stabilized sand, in the ratio of 1:4, with the minimum height of 20 cm.

Depending on the chamber's location in the road lane and on the traffic category, tops of appropriate classes should be used, as per EN 124 standard.

For PRO chambers, the offer includes telescopes with a cast iron top, with a full cover or a gully. The classes of tops to be used in roads are min. B125 (pedestrian roads and areas), C250 (road shoulders, max. 0.5 from the curb to the traffic path) and D400 (roadways).

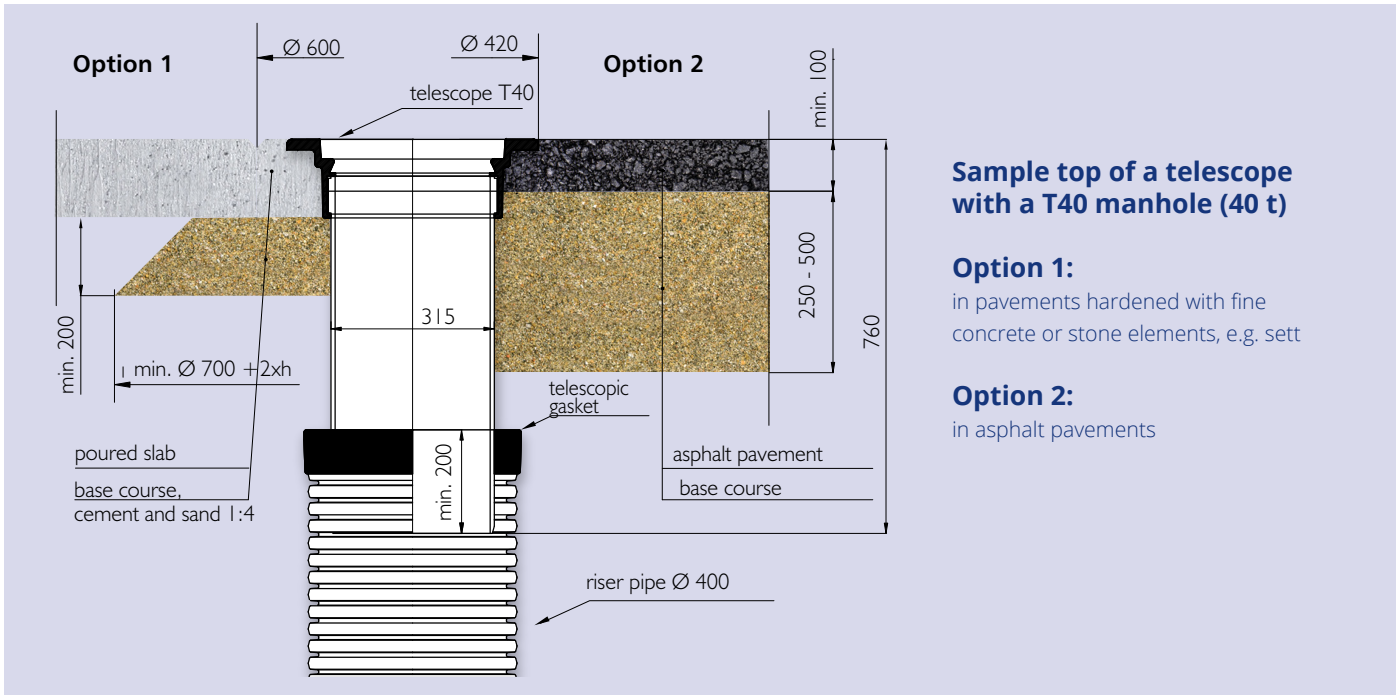

Sample top of a telescope with a T40 manhole (40 t)

Option 1:

in pavements hardened with fine concrete or stone elements, e.g. sett

Option 2:

in asphalt pavements

Gullies

Pipelife gullies are equipped with grates locked with an M10 hex socket head screw. A T50K gully additionally has a cover mounted on hinges.

In T30K and T50K gullies it is possible to install a steel handle with a catchment basket made of PE or galvanized steel.

- 1 gully
- 2 catchment basket
- 3 catchment basket holder
- 4 chamber



Gully slot areas

Gully	Slot area [cm ²]	Slot area [%]
T05DK	233.49	34.2
T30K	264.3	36.4
T50K	419	43
D400K	-	31

According to EN 124 standard, the minimum slot area should be 30%.

15.5. Manholes to PRO 400 chambers, class A15

Such tops include manholes to be directly installed on the riser pipe:

T15 DW

cast iron manhole with the diameter of 400 mm, for a DW structural pipe.

15.6. Concrete chamber tops

A concrete chamber top consists of:

- A reinforced concrete or cast iron cover
- A reinforced concrete ring, providing support for the cover

The covers should be used together with a concrete ring. The ring should be laid on compacted soil, around the riser pipe, to provide a free space of 4 cm between the upper edge of the riser pipe and the lower plane of the cover.

Concrete and cast iron covers can transfer the maximum load of, respectively, 70.0 kN and 100 kN, and are designed to be used as tops for sewer and drainage chambers in the areas with no road traffic, such as parks, greenery areas, pedestrian routes, etc.

Thanks to a high level of unification of Pipelife products, a designer can select and combine telescopes (with an appropriate manhole), riser pipes and concrete covers, as well as chamber bases, in any configurations, as the case may be.

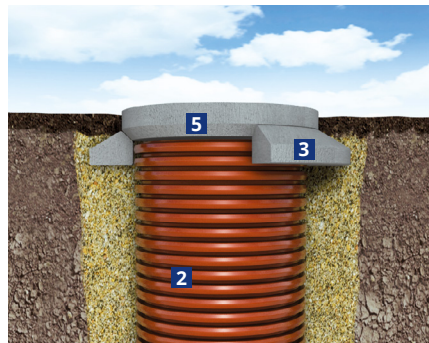
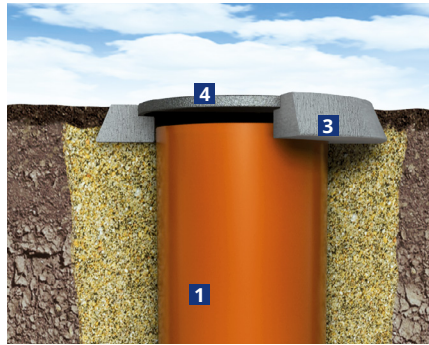

- 1 PVC-U riser pipe
- 2 PP riser pipe
- 3 concrete ring
- 4 cast iron cover
- 5 concrete cover

16. EXAMPLES OF STRUCTURAL SOLUTIONS AND APPLICATIONS OF CHAMBERS

16.1. Sewer chambers without catchment tanks, with a cast iron manhole

A chamber without a catchment tank consists of:

- A chamber base
- A riser pipe
- A telescope with a cast iron manhole

Such chambers can be used, depending on the configuration of the base and telescope combination, as follows:

- Small chamber bases with the upper socket diameter of 200 mm and the straight-through pipe diameter of 110 – 160 – 200 mm, with a T20 telescope – recommended for use as inspection chambers and at

household sewer connections,

- Other chamber bases are used on main sewers, and the application of an appropriate telescope depends on the place of chamber installation:
 - T30, B125 (T30K) – cast iron manhole, 12.5 t, used in areas of small road traffic load;
 - T50K – cast iron manhole, 25 t rain cover, used at curbs, can reach up to 0.5 m into the traffic path, measuring from the curb, and 0.2 m into the pedestrian route;



- T40, D400 (D400K) – cast iron manhole, 40 t, used in areas of high traffic load: roads, sidewalks, squares, etc.
- T05M (T4D) – cast iron manhole, 5 t, used in greenery areas, with no road traffic.

Chambers without catchment tanks can be

used in drainage systems as control chambers for junction pipelines, in construction drainage main sewer pipes, as well as at the bends of the route and at connection points of drainage pipelines, where catchment tanks are not required.

16.2. Sewer chambers without catchment tanks, with a concrete manhole

The chamber consists of:

- A chamber base
- A riser pipe: DN 400 mm (PP-B or PVC-U), DN/ID 315 mm (PP-B) or DN 200 mm (PVC-U)
- A reinforced concrete ring
- A reinforced concrete or cast iron cover

Such chambers, depending on the location, can serve as inspection chambers, and be used at household sewer connections.

Chambers with a concrete or cast iron cover supported by a concrete ring can also be used as versions of:

- Sewer chambers with catchment tanks
- Drainage chambers with or without catchment tanks

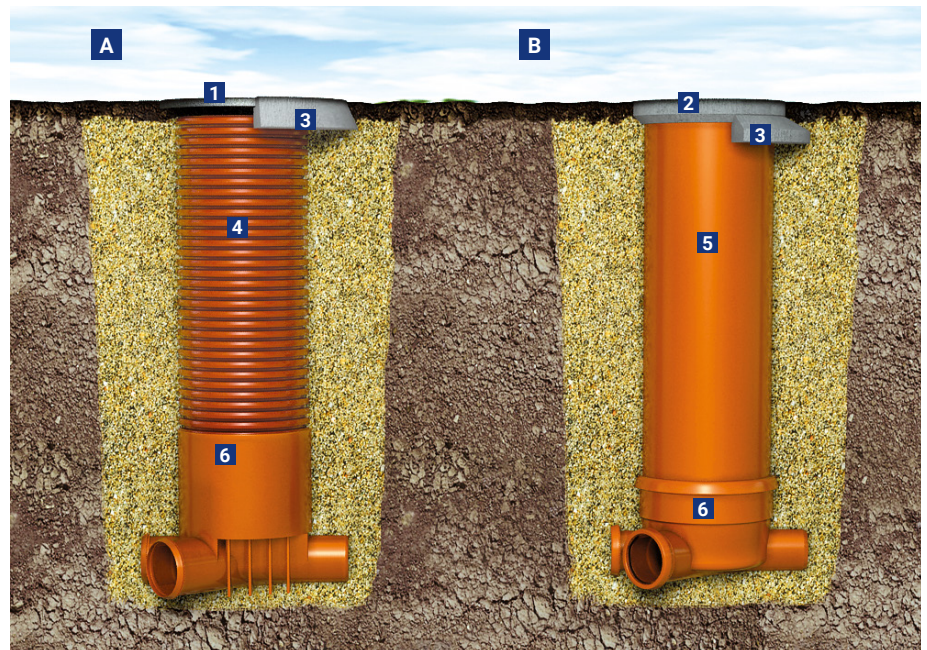

- A** Illustration of a sewer chamber with a concrete cover
- B** Illustration of a sewer chamber with a concrete cover, on a concrete ring
- 1** cast iron cover

- 2** concrete cover
- 3** concrete ring
- 4** PP-B riser pipe
- 5** PVC riser pipe
- 6** PP-B chamber base

16.3. Cascade sewer chambers

Cascade chambers are sewer chambers without catchment tanks, consisting of:

- A base appropriate for a given chamber
- A riser pipe
- A telescope with an appropriate manhole
- Gaskets for inlets
- Inlet stub pipes

Pipes are led from a higher level to a lower one using proper fittings, so that the sewage flow is guided through the chamber in an untroubled way.

To ensure the possibility of additional cleaning of the pipes, an access eye pipe should be connected to the chamber. Inlet holes are drilled at the desired height of the sewer chamber riser pipe. Then, gaskets and stub pipes are put into the holes. The method of preparation and elements of connections are described in the point: "Sewer chamber

with a catchment tank".

It is possible to make a sewer chamber without leading the external pipe to the chamber base level (Fig. b). As opposed to PRO 1000 and larger chambers, PRO 400 and PRO 315 are inspection chambers, so it is not necessary to insert a pipe to the external pipe base level.



Solutions of cascade chambers depending on the pipes diameter:

- A** Illustration of a chamber for pipes ≥ 250 mm
- B** Illustration of a chamber for pipes ≤ 200 mm

- 1** gasket
- 2** stub pipe
- 3** 45° tee pipe
- 4** 45° elbow
- 5** 45° node
- 6** access eye pipe

16.4. Sewage chambers with a catchment tank

Chambers with a catchment tank may be made based on PP-B riser pipes with the diameters of 630 mm, 400 mm and ID 315 mm. Chambers with a catchment tank for storm sewer systems are made from PP-B structural pipes with the diameter DN 400 mm and the height of 2 m for pipes with the diameter up to 250 mm. For pipes with the diameter from 160 mm to 400 mm, the chamber with a catchment tank may be made from PP-B structural pipes with the diameter of 630 mm and the height of 2 m. At the inlet and the outlet of the chamber, socket stub pipes are located at an appropriate height. The top of the chamber may be made using a telescope with a cast iron manhole and Pipelife gully or using standard cast iron manholes for manhole chambers. If sewage gullies are connected to the combined sewer system, a siphon has to be provided on a house sewer.

A 400 mm, 630 mm sewer chamber with a catchment tank consists of:

- A riser pipe with a catchment tank
- A bottom
- A top, e.g. a telescope topped with a cast iron manhole or a gully
- Gaskets at the inlet and the outlet
- Inlet and outlet stub pipes

Sewer chambers with a catchment tank are used in storm sewer systems. The chamber installation place influences the use of an appropriate telescope type:

- T30K, B125K D400K** used in roads with low traffic load used in conditions of intensive storm water inflow and in places where the presence of a significant amount of dirt, e.g. leaves, is possible (it is especially recommended for such conditions)
- T50K** used at curbs in conditions of high traffic load of 40 t, and in yards with the load of 35 t
- T05M** used in places with no road traffic (parks, gardens, for de-watering motorway shoulders)

Chambers with a catchment tank with the diameter DN/OD 630 mm with a 315 mm telescope are used for de-watering, drainage and water distribution. They consist of:

- The base made from a structural riser (double wall) Pragma pipe with the diameter DN/OD 630 mm and a bottom. In order to create a catchment tank, in the base, at an appropriate height, inlet and outlet holes are made for PP socket stub pipes which can be connected with a PVC-U pipe, DN 160÷400 mm, Pragma DN/OD 160÷400 mm or Pragma+ID DN/OD 200÷400 mm using adapters
- 630/400 mm PP reducer for connection with a PVC-U 315 telescopic pipe, through a DN 400 manchette gasket. If there is no reducer, then a 630/535 mm manchette elastomer gasket, a 535/805 mm adapter and a top are used.
- Smooth wall PVC-U pipe with the outer diameter $d_n=315$ mm, with a cast iron chamber cover installed, or without a reducer, a telescope or an adapter – in the latter case, the riser pipe is loosely inserted in-

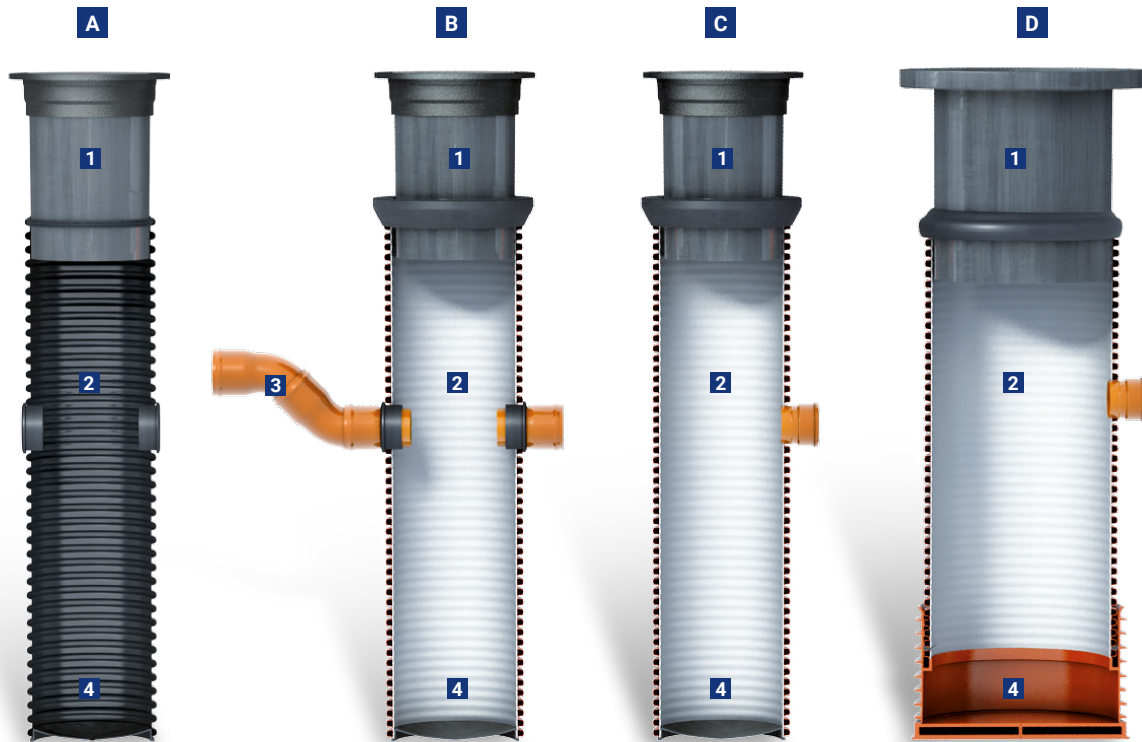

- A** PRO 315 or PRO 425 chamber with a catchment tank with a chamber bottom and a gasket, and an in-situ gasket
- B** Structural illustration of a sewer chamber with a 400 mm PP-B catchment tank, with an in-situ gasket
- C** PRO 400 or PRO 630 PP-B chamber with a catchment tank with a socket, d_n 160÷250 mm, $h=2$ m
- D** PRO 630 PP-B chamber with a catchment tank with a socket, d_n 160÷400 mm, $h=2$ m

- 1** telescopic pipe
- 2** riser pipe
- 3** siphoning – two 45° elbows
- 4** catchment tank

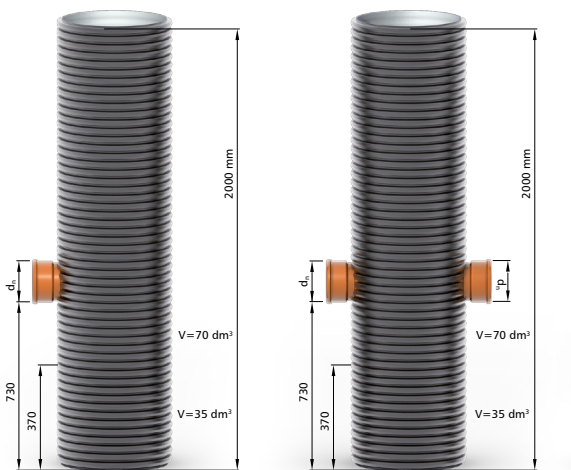

A

B

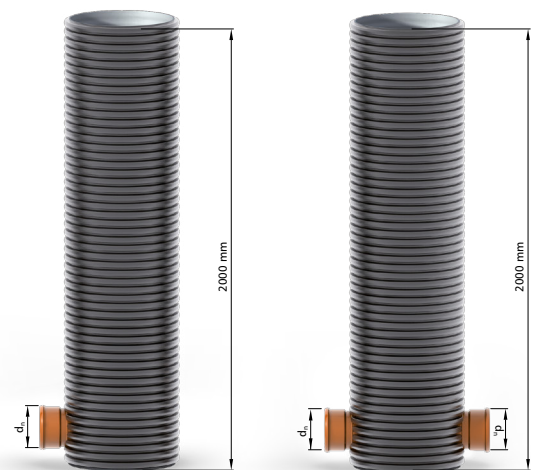

C

D

PRO 400 PP-B chambers with a catchment tank with a 70 dm³ or 35 dm³ catchment tank

- A** with a socket, d_n 160-250 mm – 1 pc.
- B** with a socket, d_n 160-250 mm – 2 pcs.

PRO 400 chambers without catchment tanks

- C** with a socket, d_n 160-250 mm – 1 pc.
- D** with a socket, d_n 160-250 mm – 2 pcs.

to the hole of the frame and cover.

- Upon specific order, we can manufacture chambers with a catchment tank consisting of PP-B riser pipe DN/ID 500±1000 mm and a bottom.

Note:

The 630/400 mm reducer is connected with the 630 mm riser pipe by welding.

16.5. Drainage chambers

In agricultural and construction drainage systems, the following chamber types are used most often:

- Chambers aligned with the ground level, without a catchment tank
- Chambers aligned with the ground level, with a catchment tank
- Underground chambers, with a catchment tank
- Underground chambers, without a catchment tank
- Underground reduction chambers

Junction drainage chamber without a catchment tank raised above ground level – sample solutions

The chamber consists of:

- A 400 mm PP-B riser pipe, type DW
- A PP-B bottom
- Gaskets, as well as inlet and outlet stub pipes
- A top:
 - A reinforced concrete cone with a concrete cover and a 400 mm cast iron manhole
 - A 400 mm cast iron manhole, type T15 DW
 - A 400 mm PP manhole for a DW pipe
 - A 315 mm telescopic pipe with a cast iron manhole



Drainage chamber without a catchment tank

- 1 riser pipe
- 2 bottom
- 3 ballast
- 4 concrete ring
- 5 gasket
- 6 stub pipe
- 7 perforated pipe
- 8 top, e.g. concrete cover

Drainage chamber raised above ground level, with a catchment tank – sample solutions

Such a chamber consists of:

- a PP-B 400 mm riser pipe, type DW,
- a PP-B bottom
- a top
 - a telescope terminated with a cast iron manhole or a gully,
 - a reinforced concrete cone with a concrete cover or a cast iron manhole 400 mm,
 - a PP 400 mm manhole for the DW pipe,
- gaskets of inlets and outlets, inlet and outlet drainage stub pipes

- A** telescopic top with a cast iron manhole
- B** top with a ring and a cast iron or concrete cover
- C** top with a 400 mm manhole made of PP or T15 cast iron



- 1** PP-B 400 mm riser pipe, type SW or DW,
- 2** bottom,
- 3** gravel ballast with the thickness of 5 cm,
- 4** gasket,

- 5** stub pipe,
- 6** perforated pipe,
- 7** sealing ring,
- 8** telescopic pipe,

- 9** cast iron manhole,
- 10** concrete ring,
- 11** cast iron or concrete cover
- 12** 400 mm manhole made of PP or T15 cast iron

In 400 mm catchment chambers, the riser pipe is a PP-B pipe with the diameter DN/OD 400 mm, type DW, with the stiffness SN 4 kN/m². The catchment tank is created by cutting out inlet and outlet holes at an appropriate height. In the case of PP-B riser pipe in the standard version, if the lower edge of the outlet is at the height of 560 mm, we create a catchment tank with the capacity of 70 l, whereas if the outlet is at the height of 250 mm, the catchment tank has a capacity of 30 l. Gaskets and appropriate stub pipes are inserted in the inlet and outlet holes, to connect the collecting pipelines. These chambers can also be

made in versions without catchment tanks. In such cases, the outlet pipe hole is placed at the height of 50 mm over the chamber bottom. On site, it is possible to make catchment chambers with a PP-B 400 mm pipe, type DW, with the stiffness SN 8 kN/m². The bottom with the diameter of 400 mm, made of PP-B, is joined with the PP-B 400 mm pipe DW. The bottom should preferably be concreted with lean concrete C20/15 (former B15).

Underground drainage chamber

The chamber consists of:

- A bottom
- A 400 mm PP-B riser pipe, type DW
- A 400 mm PP manhole
- Gaskets and inlet stub pipes

Underground drainage chambers without catchment tanks:

A Reduction chamber

B Junction chamber

- | | |
|-----------------------------|-------------------|
| 1 Riser pipe | 5 Gasket |
| 2 Bottom | 6 Stub pipe |
| 3 5 cm thick gravel ballast | 7 Perforated pipe |
| 4 Cover | |

This chamber may be made in a version with or without a catchment tank, or as a reduction chamber, depending on the location of inlets and outlets in relation to the bottom. Regardless of whether a chamber is made with or without a catchment tank, the height of the draining pipeline bottom should be lower by 2/3 of its diameter than the height of the bottom of the lowest-located water supply pipeline. In justified cases, this difference can be reduced to 50 mm.

Selection of the chamber type – raised above ground level or underground – depends on the chamber’s location and intended use. Chambers raised above ground level are easily accessible. They make supervision of gatherers’ activities and mud removal easier, however, they disturb cultivation. For this reason, they are used only in places where there is a need for frequent inspection and mud removal from catchment tanks, i.e. in dusty and ferruginous soils.

These chambers are best to be located in places where no crops are cultivated, near roads and at the boundaries of fields. Inspection of underground chambers is more difficult, as it entails the need to find the chambers and dig them out. Their use is justified if field works are strongly mechanized.

To facilitate location of underground chambers in the field, it is advised to place identification metal pieces on the chambers covers during their installation, and to use a metal detector during inspection works.

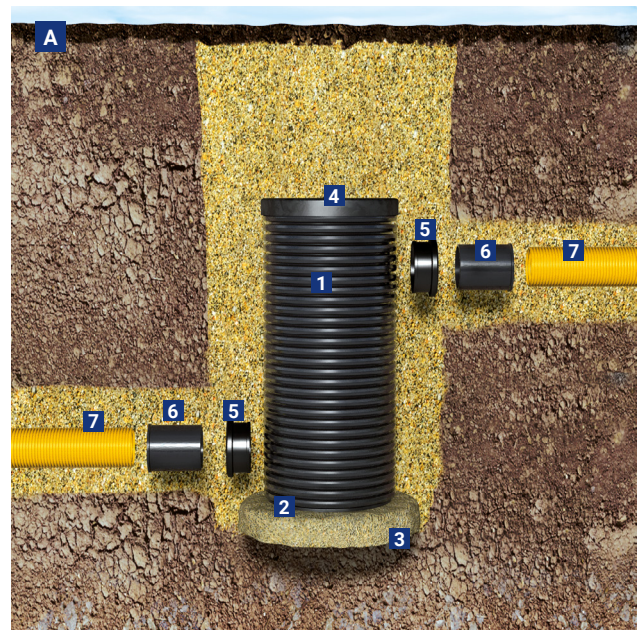

16.6. In-situ gaskets

Drainage chambers with a 400 mm PP-B pipe have factory-made holes with a 80/100/110 mm gasket. The gasket enables connection with a 100 mm drainage pipe or a PVC-U 110 mm sewer pipe.

Upon order from the Customer, 400 mm chambers can have holes

with the diameter of 160 mm.

Pipeline also offers four-lip gaskets with the diameter of 110-315 mm.

16.7. Use of plastic chamber bases in old concrete chambers – examples

Chambers made of traditional materials (concrete, bricks) often fail to provide sufficient tightness, especially against the infiltration of ground-water into the sewer system.

If, for some reasons, it is advisable to use traditional “wet-made” concrete chambers made in situ from large diameter (i.e. 1.0; 1.2 m or larger) concrete or bricked rings, then, it is also possible to successfully use PP chamber bases which are used in Pipelife sewer systems. For this purpose, a PP chamber base is installed at the bottom of a traditional chamber, at the designed level. Pipes and fittings are joined directly with the base, thus creating a tight, hydraulically efficient sewer system. The chamber foundation should preferably be made of bricks, and the bottom should be made of concrete poured in situ, with a proper inclination. It is also possible to install the whole set in concrete rings (or use a different solution).

Further elements of the chamber are set on the so prepared foundation.

The use of plastic chamber bases in concrete chambers is recommended especially for renovation of old concrete, stoneware and other sewers using the relining method.

In this case, in order to reduce costs and conduct the work efficiently, old traditional chambers are not removed. The installed chamber bases provide excellent tightness of the system.



Example of use of a plastic chamber base during renovation of concrete chambers using the relining method

17. TECHNICAL GUIDELINES

17.1. Location of sewer pipes and chambers

Sewer chambers should be located with the observance of the following requirements:

1. Provide access for vehicles to the chamber for necessary maintenance activities.
2. Avoid locating the chambers in hollows and other places where storm water might accumulate.
3. In no-manhole pipes, use chambers at each direction change, inclination and section point, as well as on straight sections at distances not exceeding 60 m.
4. Sewer chambers situated in roadways should be located in places least exposed to the impact of road traffic.

Sewer system pipes should be situated:

1. In built-up area:
 - In the existing and designed streets, in delimitation lines of streets, beyond roadways;
 - In service, local and access streets, it is acceptable to situate a storm or combined sewer under the roadway (if this sewer is used to de-water these streets).
2. Beyond built-up area:
 - Along the roads beyond the roadway lane, e.g. in a shoulder or in the field, ensuring access for vehicles to the sewer.

The use of thermoplastic chambers and pipes, as well as modern equipment for inspection and cleaning of the sewers makes it possible to increase the distance between manhole chambers up to 100 m.

Basic distances of the gauge of gravity sewer system pipes from building structures and greenery

No.		Building structure or greenery	System pipes gauge distance
	Type	Place of reference for determining the distance	Distance of the gravity sewer system pipe gauge [m]
1.	Buildings, building line	continuous footing projection line, building line on a base map	4.0
2.	Fencings, delimitation lines	fencing line, line specified on a base map	1.5
3.	Petrol stations	tank edge lines	3.0
4.	Petrol stations	boundary of the area	3.5
5.	Bridges, flyovers	support structures edge line	4.0
6.	Tram tracks	railway gauge	2.0
7.	Railway tracks laid a) at the ground level • main tracks • local tracks and sidings	railway gauge	5.0
	3.0		
	b) below ground level in an excavation • main tracks • local tracks and sidings	upper edge of the excavation	5.0 3.0
c) on embankments • main tracks • local tracks and sidings	embankment base	5.0	
		3.0	
8.	Pole power lines	pole or support foundation edge	1.0
9.	Data communication lines • cable lines • cable ducting • pole lines	cable axis structure edge pole axis	0.8
			0.8
			1.0
10.	Water supply pipes DN≤300 300<DN≤500 DN>500	pipe gauge	1.2
			1.4
			1.7
11.	Heating systems • channel systems • pre-insulated systems	channel base gauge	1.4
		pipe gauge	1.2
12.	Roads	road drainage ditch edge	0.8
13.	Street roadways	roadway edge	1.2
14.	Trees • existing • natural monuments	tree's centre point	2.0
			15.0

17.2. General requirements

When conducting the works, it is necessary to make sure that the design assumptions for the project are sufficient, safe and adequate to variable conditions, especially with regard to:

1. The excavation width in comparison with the designed one
2. The excavation depth in comparison with the designed one
3. The excavation shuttering system and the effect of its removal
4. The compaction level of the pipe installation zone
5. The compaction level of the main backfill
6. The pipe and excavation bottom securing conditions
7. Temporary and road traffic loads
8. Soil type and parameters (e.g. subsoil, excavation walls, backfill)
9. The excavation shape (e.g. an excavation with slanting walls, stepped excavation)
10. Ground and soil condition related to weather conditions (e.g. frost, thaw, snow, rain, flood)
11. Ground water level
12. Other pipes in the same excavation

Attention must be paid not to make excavation long before installation of pipelines. Avoiding excessively long sections of open excavations will bring certain benefits, namely:

- Limitation, or even elimination, of the need for draining or shuttering the excavations,
- Minimized flooding hazard,
- Reduction in the amount of soil being washed out from the excavation bottom with ground water,
- Avoidance of freezing of the soil from the excavation bottom and of the backfill material,
- Reduced hazard for people, as well as for vehicles and equipment traffic.

To make sure that the supplied products are not damaged, they should be checked both upon delivery and right before the installation of the pipe.

17.3. Ground materials

The ground materials used in the installation area should ensure constant stability and carrying capacity of the chamber and the pipes backfilled in the ground. The ground materials should not have an adverse impact on the chamber, the pipes or the ground water.

The ground materials used in the chamber installation zone should comply with the design requirements. They can be either subsoil, if it is suitable, or materials supplied from beyond the excavation. It is recommended to ensure that the materials used for the ballast do not contain particles larger than 22 mm.

Subsoil can be re-used if it meets the following requirements:

- It complies with the design requirements,
- It can be compacted,
- It does not contain any materials that could damage the chamber and the pipe (e.g. particles above the acceptable sizes, tree roots, waste, organic materials, clumps of ground > 75 mm, snow and ice)

Granulated ground materials supplied from beyond the site include:

- Single-fraction material
- Multi-fraction material
- Sand
- Natural aggregates
- Broken aggregates.

17.4. Excavation backfill

The preparation of the gravel pack and the main backfill can commence only after the joints and the base are prepared for receiving load.

The space between the excavation wall and the chamber, within the radius of 0.5 m from the chamber, should be gradually, evenly backfilled in layers with the thickness of 0.2-0.3 m of compacted (e.g. using a vibratory rammer) sandy soil of group 1-3. This layer should be spread evenly on the whole circumference of the chamber, to avoid asymmetrical loading of its side walls. The compaction index should be, in green areas, 90% SPD, and in roads 95%-100% SPD. If ground water is present above the chamber bottom, the compaction should reach 98%-100%.

Where required, it is recommended to compact the initial backfill directly over the sewer pipe connected to the chamber manually. Mechanical compaction of the main backfill may begin when the thickness of its layer over the pipe top reaches at least 300 mm. The total thickness of the layer directly over the pipe before beginning the compaction depends on the type of equipment used (see the Table on page 33). The selection of the compaction equipment, as well as the determination of the number of compaction operations and the thickness of the layer to be compacted should be made taking into account the type of the ground material and the pipe material. In low temperature conditions (below 0°C), particular caution should be exercised when compacting the soil over the PVC-U pipes. PP-B polypropylene Pragma structural pipes are resistant to low temperatures, and as such, they can be installed in winter conditions.

Compaction by saturation of the gravel pack with water is acceptable in exceptional situations, and only in suitable non-cohesive soils.

The soil for gravel pack and compaction cannot be frozen or clumped. The following tables provide the criteria and suitability for use as a gravel pack material. If no details are given as to the subsoil, it is assumed that this soil has the compaction index corresponding to the value from 91% to 97% SPD (standard Proctor density).

It is recommended to confirm the soil compaction index using one or several of the following methods:

- Direct monitoring of the backfilling process
- Verification of initial deformation of the installed pipe
- Verification of the compaction index on site.

Compaction index

Description	Compaction index			
Standard Proctor scale ¹⁾ [%]	≤ 80	81 to 90	91 to 94	95 to 100
Blow sieve number	0 - 10	11 - 30	31 - 50	> 50
Expected consolidation levels achieved in compaction classes	NOT (N)			
		MODERATE (M)		
		WELL (W)		
Loose soil	loose	moderately compacted	compacted	well-compacted
Cohesive and organic soil	soft	dense	rigid	hard

¹⁾ Determined as per DIN 18127.

Soil compaction indexes for particular compaction classes

Compaction Class	Description			Backfill material group			
	French	German	4 SPD %	3 SPD %	2 SPD %	1 SPD %	
Not (N)	Non	Nicht	75 do 80	79 do 85	79 do 85	84 do 89	
Moderate (M)	Modéré	Mäßig	81 do 89	86 do 92	86 do 92	90 do 95	
Well (W)	Soigné	Gut	90 do 95	93 do 96	93 do 96	96 do 100	

SPD – Standard Proctor Density

“Well” compacted soil

Grainy soil gravel pack is thoroughly distributed in pipe fillets and compacted. Then the soil is backfilled in layers of max. 30 cm and each layer is thoroughly compacted. Typical compaction values in the standard Proctor scale are higher than 94%.

“Moderate” compaction

Grainy soil gravel pack is distributed in layers of max. 50 cm, and each layer is thoroughly compacted. Typical compaction values in the standard Proctor scale are from 87% to 94%.

The compaction index is a function of a material group and a compaction class. To make the gravel pack, it is possible to use lower-quality soil, from a lower group, e.g. instead of group 1 (gravel) in class M, it is possible to use soil from group 2 (sand), but with a higher compaction index in class W. In practice, there is a need for more compactations of the soil, from 3 to 6, depending on the equipment used; the thickness of compacted soil layers should also be lower.

Note:

In areas exposed to road traffic load, it is necessary to use the W class compaction. This means that compaction of soil in the road at the level of min. 95% - 100% SPD should be achieved using loose soils (gravel, sand) from group 1 or 2.

In areas not exposed to road traffic load, in order to achieve soil compaction of min. 90% SPD, it is advisable to use compaction of min. M class, and loose soils (sand) from group 2. Please note that the soil compaction of min. 90% SPD for class N should be achieved using only loose soils (gravel) from group 1. It is not allowed to use soils from group 2, 3 and 4, e.g. sand with discontinuous grain size, loamy gravel, loamy sand, clayey sand, as well as loam and clay cohesive soils.

If sheet pile walls are used, it is recommended, in accordance with EN 1610, to remove

the excavation support before compaction. If, however, parts of the excavation support are removed after compaction it is advisable to reduce the compaction level from “W” (well-compacted) or “M” (moderate) to “N” (not compacted).

Due to backfilling, with simultaneous removal of sheet pile walls supporting excavation walls, empty spaces may appear around a chamber or a pipe. To avoid it, it is necessary to maintain the minimum distance between the pipe wall and the excavation wall, equal to min. $3 \times d_n$ of the pipe (three times the pipe diameter).

Soil groups and their suitability for use as a backfill material

Soil type	Soil group					Possibility to use for backfill
	No.	Common name	Symbol*	Characteristic traits	Examples	
loose	1	Gravel of discontinuous grain size	(GE) [GU]	Steep grain size curve, prevalence of one fraction	Broken stone, river and sea gravel, moraine gravel, scoria, volcanic ash	YES
		Gravel of continuous grain size, sand and gravel mix	[GW]	Continuous grain size curve, several fractions		
		Sand and gravel mix of discontinuous grain size	(GI) [GP]	Stepped grain size curve, some fractions absent		
	2	Sands with discontinuous grain size	(SE) [SU]	Steep grain size curve, prevalence of one fraction	Dune, outwash, valley and basin sand	YES
		Sands with continuous grain size, sand and gravel mix	[SW]	Continuous grain size curve, several fractions	Moraine, terrace and seashore sands	
		Sand and gravel mix	(SI) [SP]	Stepped grain size curve, some fractions absent		
loose	3	Loamy gravel, loamy sand and gravel mix of discontinuous grain size	(GU) [GM]	Discontinuous grain size, content of loamy fraction	Weathered gravel, rock debris, clayey gravel	YES
		Loamy gravel, clayey sand and gravel mix of discontinuous grain size	(GT) [GC]	Discontinuous grain size, content of fine clay		
		Loamy sand, sand-loam mix of discontinuous grain size	(SU) [SM]	Discontinuous grain size, content of fine loam	Watered sand, clayey sand, sand loess	
		Clayey sand, sand-clay mix of discontinuous grain size	(ST) [SC]	Discontinuous grain size, content of fine clay	Clayey sand, alluvial clay, marl	
cohesive	4	Inorganic loam, fine sand, stone dust, loamy and clayey sand	(UL) [ML]	Low stability, quick mechanical response, plasticity from zero to low	Loess, sandy clay	YES
		Inorganic clay, highly plastic clay	(TA) (CTL) (TM) [CL]	Stability from medium to very good, not particularly slow mechanical response, plasticity from low to medium	Alluvial marl, clay	
organic	5	Multi-fraction loose soil with humus admixture	[OK]	Vegetable and non-vegetable admixtures, putrid smell, low volumetric weight, high porosity	Humus, chalky sand, tuff	NO
		Organic loam and organic clay-loam mixture	(OU) [OL]	Medium stability, mechanical response from medium to very quick, plasticity from low to medium	Sea chalk, humus	
		Organic clay, clay with organic admixtures	[OH] (OT)	High stability, no mechanical response, plasticity from medium to high	Loam, moulding clay	
	6	Peat, other highly organic soils	(HN) (HZ) [Pt]	Fibrous peat formed during decomposition, colour: from brown to black	Peat	NO
		Silts	[F]	Slime deposited at the bottom of a watercourse, often mixed with sand/clay/ chalk, very soft	Silt	

* Symbols in parentheses (...) come from German standard DIN 18196.
Symbols in brackets [...] come from British standard BS 5930.

In general, the backfill may be made using non-cohesive loose soils belonging to groups from 1 to 3, as well as cohesive soils from group 4.

However, attention has to be paid to the limitations in the use of group 4 soils, involving the achievement of the desired compaction index, lower thicknesses of compacted layers, as well as a very long consolidation period of clayey soils, which can take up to several years after the installation completion, in result of road traffic load.

Additional requirements for the subsoil used

in the pipe backfill area:

It does not contain particles larger than the respective limit value

It does not contain ground clumps twice the size of a respective maximum particle size

It does not contain frozen material

It does not contain waste (e.g. asphalt, bottles, cans, wood)

Where compaction is required, the material should be prone to compaction.

If the subsoil belongs to groups 5 or 6 (organic soils), the backfill should be made of exter-

Maximum particle size	
Nominal diameter DN	Maximum size [mm]
DN < 100	15
100 ≤ DN < 300	20
300 ≤ DN < 600	30
600 ≤ DN	40

nal soil, transported to the construction site.

Recommended soil layer thicknesses and the number of compaction operations, depending on the equipment used

Equipment	Number of compactions (operations) for compaction classes		Max. layer thicknesses, in metres, after compaction for the soil group				Minimum thicknesses above the pipe top before compaction [mm]
	Well W	Moderate M	1	2	3	4	
Foot or hand rammer min. 15 kg	3	1	0.15	0.10	0.10	0.10	0.20
Vibratory rammer min. 70 kg	3	1	0.30	0.25	0.20	0.10	0.30
Plate vibrator min. 50 kg	4	1	0.10	-	-	-	0.15
min. 100 kg	4	1	0.15	0.10	-	-	0.15
min. 200 kg	4	1	0.20	0.15	0.10	-	0.20
min. 400 kg	4	1	0.30	0.25	0.15	0.10	0.30
min. 600 kg	4	1	0.40	0.30	0.20	0.15	0.50
Vibratory roller min. 15 kN/m	6	2	0.35	0.25	0.20	-	0.60
min. 30 kN/m	6	2	0.60	0.50	0.30	-	1.20
min. 45 kN/m	6	2	1.00	0.75	0.40	-	1.80
min. 65 kN/m	6	2	1.50	1.10	0.60	-	2.40
Twin vibratory roller min. 5 kN/m	6	2	0.15	0.10	-	-	0.20
min. 10 kN/m	6	2	0.25	0.20	0.15	-	0.45
min. 20 kN/m	6	2	0.35	0.30	0.20	-	0.60
min. 30 kN/m	6	2	0.50	0.40	0.30	-	0.85
Heavy tripple roller (no vibrations) min. 50 kN/m	6	2	0.25	0.20	0.250	-	1.00

18. INSTALLATION OF PRO 200, PRO 315, PRO 400, PRO 425 CHAMBERS

18.1. Operation of the chambers in various conditions

The structure of Pipelife chambers has been designed in such a way that even in most adverse ambient conditions it would guarantee system tightness and prevent damage to the chamber and – consequently – to the pipe.

The chambers prove to cooperate really well at:

- Transferring road traffic loads
- Transferring loads caused by temperature fluctuations
- Variable ground and water conditions
- Adjustment and during pavement repair

Pipelife offers PP sewer chambers with smooth PVC-U riser pipe, with diameters dn 200 and 400 mm, and the latest generation of G3 PRO 315, PRO 400 and PRO 425 chambers with a structural (profiled) riser pipe made of PP-B. Chamber bases with the diameters dn 160 and 200 mm have sockets of Eurosocket type, on all their branches and outlets. Bases with the diameters dn 250 – 400 mm for connecting PVC-U sewer pipes have a gasket with a ring preventing the gasket from slipping out. The chamber base is made of in-

jection moulded PP-B (polypropylene block copolymer) with very high resistance to impacts, great resistance to both low and high temperatures, as well as long life span and high chemical resistance, which is especially important in the case of aggressive sewage. PRO 315, 400, 425 chamber bases also have a specially profiled bottom, with an inclination of 2%, which, in combination with smooth surface, provides very good hydraulic performance.

The new generation sewer chambers are suitable for direct connection to pipes made from PVC smooth wall pipes and Pragma polypropylene pipes (with the use of adapters). In the new generation of the chambers, a number of important modifications have been introduced:

- The use of a pipe with the structural wall DN/OD 400, DN/OD 630 mm (profiled outside and smooth inside) or DN/ID 315, DN/ID 425 (single-wall corrugated pipe)
- Riser pipe made of PP-B (polypropylene block copolymer), providing:

- Lower pipe weight
- Higher resistance to impacts
- Much higher resistance to low and high temperatures
- Much higher chemical resistance, as compared to PVC pipes
- Increased strain compensation
- Inclination towards the flow direction: 2%
- Ribs stiffening the structure, additionally improving the conditions of foundation and ground compaction around the chamber base
- Chambers have Eurosockets for PVC-U smooth wall pipes
- Four types of chamber base configuration (straight-through, junction with a 45° right or left branch, junction with a 45° right and left branch).

18.2. Transfer of thermal and dynamic loads

The essence of telescopic structure is ensuring that the loads generated by road traffic and variable weather conditions are not transferred to the chamber base. At the same time, the surfaces of the chamber manhole and the road should be levelled at all times. Solutions developed by the Pipelife Group provide the fulfilment of such requirements, by an appropriate method of compacting the ground around the chamber, and by proper installation of the manhole in the pavement. The telescopic structure and the properly profiled sealing ring enable vertical movements of the telescope, both under dynamic load (see figure on the next page) and at temperature changes.

External loads (e.g. from road traffic) are transferred through a properly constructed cast iron manhole to the base course of the road and to the adequately compacted ground.

The telescope makes small micromovements, in accordance with the road pavement behaviour.

It is very important to eliminate horizontal forces acting on the manhole (telescope) of the manhole chamber. These forces are generated when cars drive and brake on the chambers. It can cause shearing (cracking) of the chamber riser.

The telescopic joint has two basic areas to receive horizontal forces.

These are:

- Flexible connection between the riser pipe and the telescope
- Place of installation of the riser pipe in a cast iron top.

The loads which can result from these conditions are compensated by flexible shift of the telescope in the riser pipe sealing ring. This helps to prevent destructive loads both in the riser pipe and the chamber base, and thus, protect the entire sewer system.

An important issue is also the ground (road) recompression phase after the cessation of load impact. The manhole, permanently fixed (anchored) in the road pavement, re-

Transfer of dynamic loads

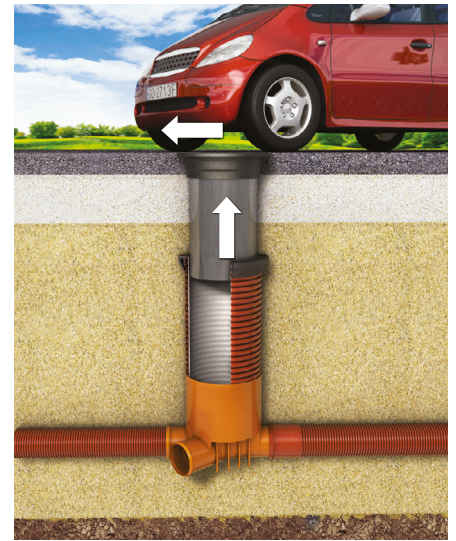
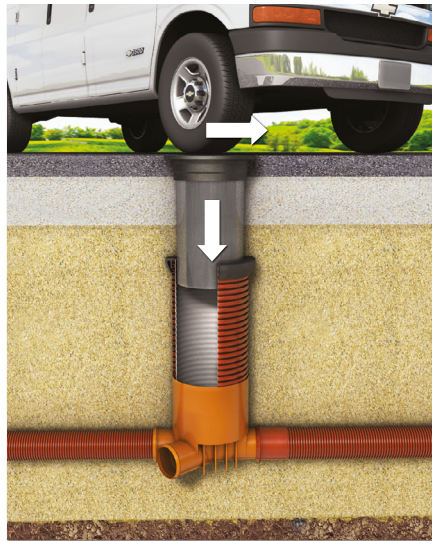

Telescope work at temperature changes

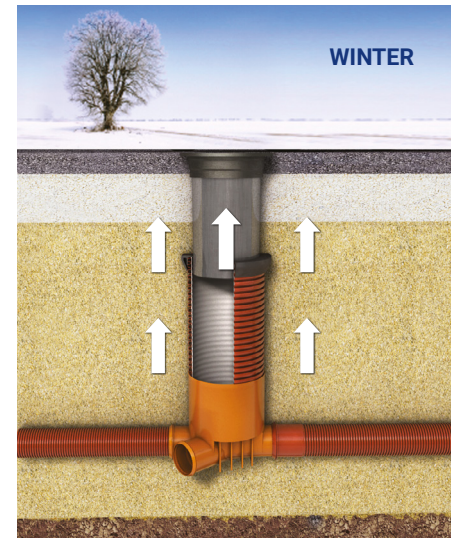
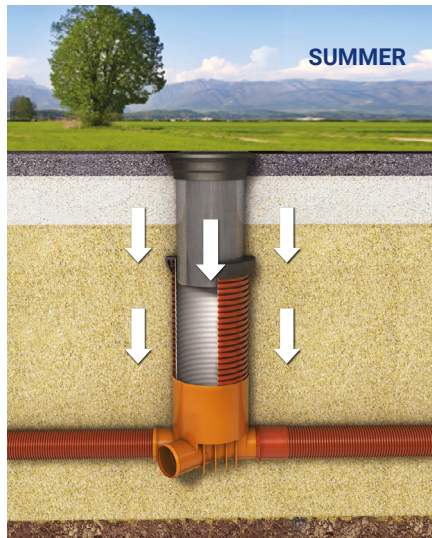

turns to its initial condition, in accordance with the return micromovement of the road. At the same time, the tensile forces acting here cause the riser pipe to be pulled out of the gasket in the chamber base, as all the loads are compensated by the telescope shift in the sealing ring.

Therefore, the smooth surface of the telescopic pipe and the possibility of movement in the pipe sealing ring ensure:

- Maintenance of levelling of the manhole surface and the road pavement
- Protection of the sewer against destructive loads
- Protection against possibility of the riser pipe being pulled out of the chamber base, due to lengthwise movements.

It is worth noting that for areas characterized by the risk of very deep frost penetration to the ground and the related significant thermal movements, Pipeline has developed, tested, and uses chamber bases with specially extended connection sockets (between a chamber base and a PVC smooth wall riser pipe or a PP-DW structural pipe). These chamber bases are manufactured and delivered upon Customers orders.

If the installation proceeds correctly, it is advised to leave a segment of the telescopic pipe, with the min. length of 20 cm, in the riser pipe (see the figure on the next page). The telescope mounted in this way, when exposed to horizontal forces, can be in any case deflected at the joint.

When installing the chambers in grounds with the water table level below the chambers installation level, with gravel pack properly made of loose materials, the stability of the structure is obvious.

In grounds with the water table stabilizing above the chamber bottom, and with a properly made gravel pack, the ground friction force on the sides of the chamber decreases, while the buoyancy increases. However, even in such extreme conditions, the structure stability factor is much higher than 1, which ensures appropriate cooperation between the chamber and the ground.

In other words, even in harsh ground and water conditions, the forces keeping the chamber stably in the ground are higher than the buoyancy.

Pipelife has developed a program to check the performance of the chambers, even in extremely difficult conditions. The telescopic pipe is also installed in a durable and flexible manner in the rim of the cast iron manhole, by hot pressing of the PVC pipe into the inlet in the manhole frame. At this point, a joint is created that permanently holds the telescopic pipe and, at the same time, letting the manhole make small oblique micromovements. A proper structure of the manhole, thanks to the edges profiled at a proper angle, ensures compensation of vertical forces, so that the resultant force on the edge is transferred mainly as a vertical force.

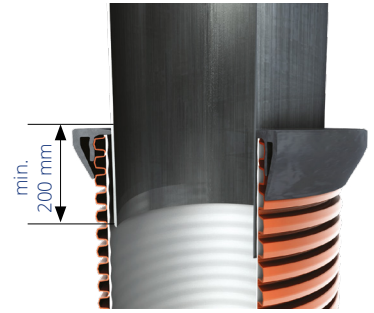

Correct installation of the telescopic pipe in the riser pipe of the chamber.

18.3. Cooperation between the chamber and the ground

Several decades of use of plastic pipes in very harsh ground/water and climatic conditions of Scandinavia, have let us gain substantial experience in achieving correct cooperation between the chambers and the ground. This experience has been further enriched both with experimental material and with theoretical calculations concerning cooperation

in various field conditions. They prove that the chambers are permanently anchored in the ground, if minimum requirements are met regarding the gravel pack, its compaction and the manner of performing all installation work, in accordance with the present catalogue and good engineering practice.

18.4. Road pavement renovation

The use of roads entails the need of their repair or complete replacement of the wearing course, which often involves raising the road elevation. Another situation may be, e.g. the need to separate a pedestrian route from a green area (a lawn), and the related need to make base course, and thus, to change the chamber manhole level. The third possibility is the frequently encountered situation when, at the roads design stage, the land elevation is not known precisely, or it changes throughout the performance of the works. All these situations strongly hinder the installation of the chambers or force the contractor to reconstruct them.

Chambers made by Pipelife, thanks to the use of telescopic manhole fitting, offer the possibility of multiple raising, adjustment and adaptation to variable land (road) elevations.

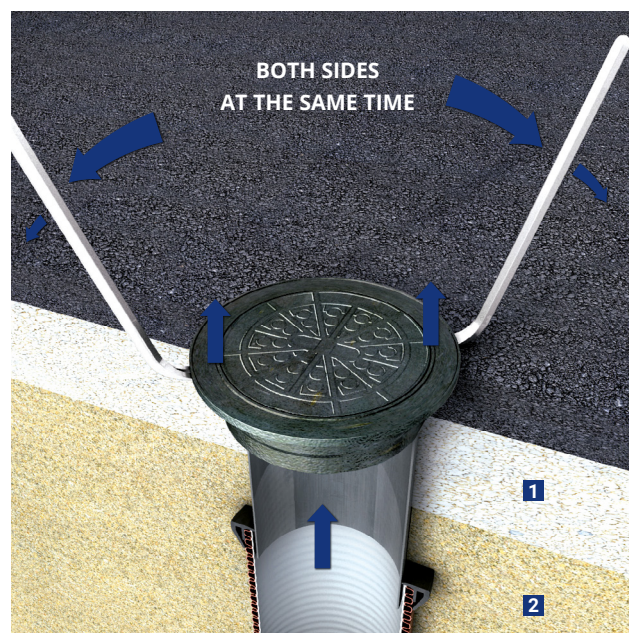

Telescope adjustment using a lever

- 1 road pavement
- 2 sand/gravel

In the described situations, it is only required to cut the riser pipe to the desired length, and leave a suitable reserve of the telescopic pipe length in the riser pipe (approx. 30-40 cm), and also leave 20 cm of the telescope length for its stabilization.

If it is necessary to adjust (raise) the manhole, we need to remove the layer holding the manhole in the ground and slide the telescope to the desired elevation, while levering the cast iron frame to the desired height. (see the adjacent figure)

Telescope adjustment using a rope

- 1 road pavement
- 2 sand/gravel
- 3 rope
- 4 wooden crossbar
- 5 winch or lever

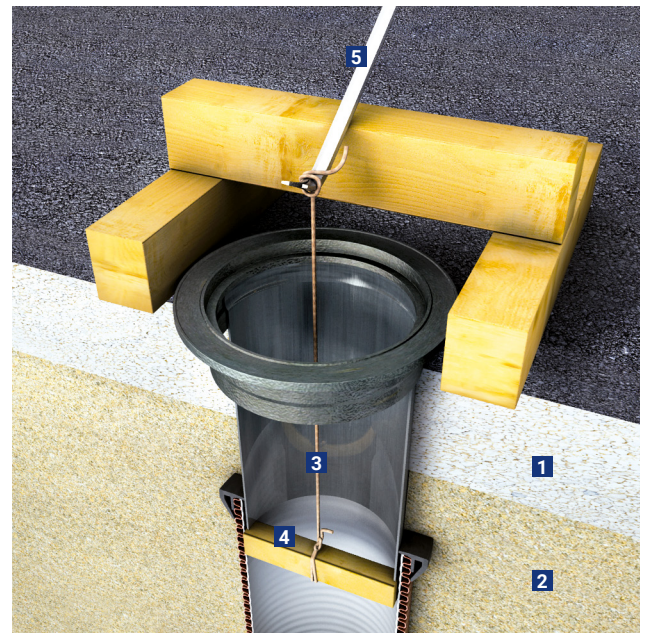

18.5. Earthworks

Excavation width must be sufficient for connecting pipes with a chamber in an untroubled way. This connection is made in a manner analogous to the connection between a spigot and a pipe socket. For a system of PVC smooth wall pipe chambers, this will mean setting the spigot in the chamber base socket (such sockets are equipped with a system of lip seals) on one side, and installing the chamber base outlet spigot in PVC pipe socket on the other. Side branches are suitable for connection with a PVC pipe spigot.

In the PP chamber system for Pragma pipes, connection will consist in sliding the Pragma pipe spigot (with a gasket placed in the first groove of the spigot) into the chamber base socket.

Both PVC and PP pipes can be connected to any chamber system (for PVC pipes and for Pragma pipes). This is made possible thanks to a special structure of the Pragma pipe socket and a chamber for this type of pipes. In order to connect two different systems, it is necessary to use: a Pragma/PVC adapter or a snap ring.

The thickness of the ballast under the chamber should be equal to the thickness of the ballast under the pipeline. Most often, it is a layer with the thickness of 15 cm. The ballast

on which the chamber is to be set may be formed in two ways:

1. The excavation should be deepened, and the chamber should be set on a ballast made from excavated soil material, after its appropriate selection and compaction.
2. Loose material brought from beyond the site should be placed in the excavation and slightly compacted.

Proper material for the backfill and filling around the chamber riser pipe may be obtained by appropriate selection of the soil dug out from the excavation, or it can be transported to the site. The material used for the gravel pack of the chamber (including the riser pipe) must be the same as the material used to make the pipeline gravel pack. The material used for backfilling the excavation should contain no boulders, sharp-edged stones, clay lumps, chalk or frozen ground.

If the pipeline requires an additional foundation, the same foundation has to be provided for the chamber. Both in the case of a pipeline and a chamber, it is required to make an appropriate levelling layer on a foundation. Preparation details, granulation, etc. are the same as described in the reference materials concerning pipeline installation.

18.6. Chamber installation – general principles

Steps taken during the installation of sewer and drainage chambers depend on their type and components. Differences in execution are related, above all, to the chamber top type at the surface (topping with a telescopic pipe with a cast iron pipe or with a ring and a concrete or cast iron cover), as well as the solution for the bottom part of the chamber (chamber with or without a catchment tank). When installing the chamber, account should be taken of specific design requirements as to the levels and elevations of the matching installation of inlet and outlet pipes in the chambers, and the placement of these pipes in relation to the chamber bottom.

Below we provide the actions related to making typical sewer and drainage chambers, the installation of which was conducted taking into consideration all components of typical chambers. The structural solutions for these chambers are included in the “Product range” part of this catalogue.

18.7. Installation of a chamber with a cast iron manhole without a catchment tank

A complete chamber consists of the following elements:

- A chamber base (available in a full range of diameters and side branches)
- A riser pipe
- A top, e.g. a telescope topped with a cast iron cover, appropriate to a given application, as per the design

Installation steps:

1 The chamber base is set rigidly on a properly prepared ballast by pressing, so as to fill the empty spaces under its bottom. The chamber is joined with the pipelines in a manner analogous to joining pipes.

2 The chamber base set in this way is backfilled to the height of approx. 15 cm above the chamber base branches. Then, the base must be prepared for installation of the riser pipe, which must first be cut with a handsaw or a chainsaw to the necessary length. The riser pipe should be cut to such a depth so that the telescopic pipe is immersed in the riser pipe at the depth of approx. 20 cm. The gasket should be cleaned and lubricated. The end section of the riser pipe should be ground, to remove jagged edges. Before the riser pipe is placed in the chamber base, it is necessary to measure the depth at which the pipe will be placed in the base (the distance between the internal taper of the chamber base and its upper edge). The segment measured in this way should be marked on the vertical pipe. The prepared riser pipe should be manually pressed into the chamber base, down to the previously marked depth. The gasket for PP corrugated riser pipe DN 400 has a symmetrical profile. The gasket should be put on the second groove of the riser pipe. Two triangular lips should be directed to the outside of the pipe.

3 Around the chamber base and the riser pipe, it is required to prepare the gravel pack in layers, very thoroughly, and to backfill the excavation reaching the required compaction index. The preparation conditions, the material, the compaction index and the equipment used are the same as in the case of pipelines.

4 The telescopic pipe sealing ring should be cleaned and lubricated from the inside, at the place where the telescope moves. Place the telescope in the riser pipe and put the cover in the manhole.

5 After the telescopic pipe is installed, it is necessary to determine the level of the cast iron manhole using a levelling rod.

6 During backfilling, special attention must be paid to even distribution of the filling around the upper part of the chamber. The filling material should be very well compacted to enable the transfer of the expected loads.

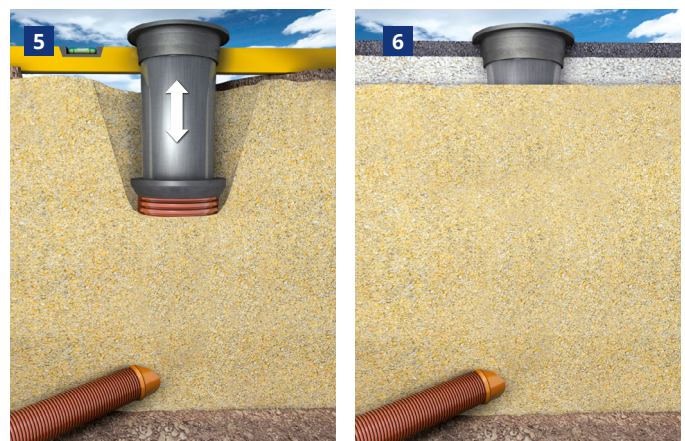
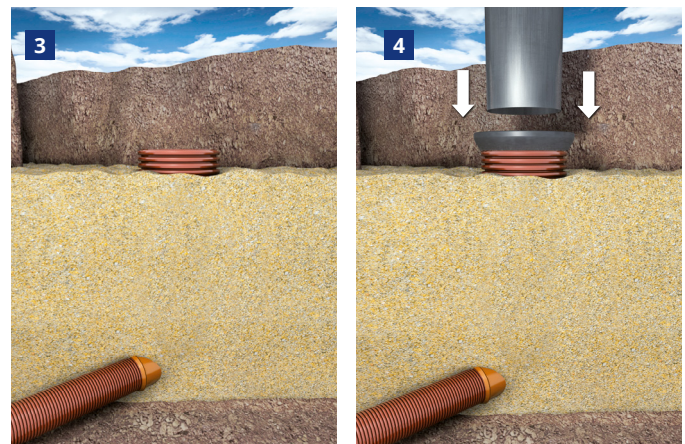
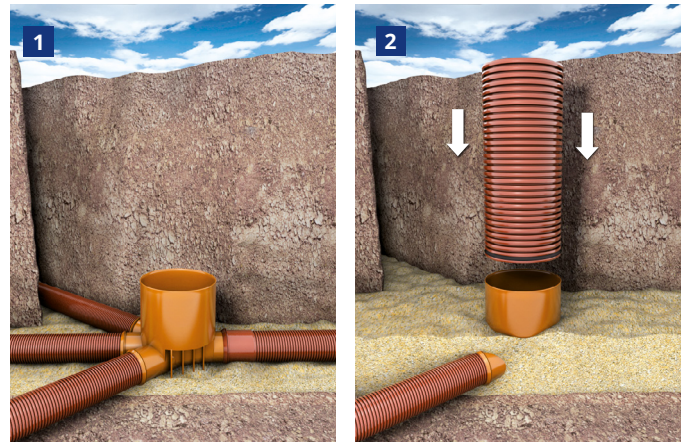

18.8. Installation of a telescope

When installing chamber manholes in roads, the following conditions have to be met:

1. Cast iron manhole frames must be immersed in asphalt at the depth of min. 100 mm (or set in a poured concrete slab at the min. length of 100 mm – see the adjacent figure)
2. In the initial phase of the works, the manhole should be raised approx. 50 mm over the asphalt surface, to provide sufficient space to perform the steps to follow.
3. It is essential to remove all sand or gravel from the top part of the chamber. Asphalt must fully adhere to the cast iron manhole frame.
4. The manhole should be set (pressed) in hot asphalt, which has to be well packed under the manhole frame.
5. Gravel or sand must be very well compacted in the area around the pipe.
6. The upper surface of the manhole must be levelled with the asphalt layer surface, not above and not below the roadway surface.
7. The road surface can be rolled together with the chamber manhole installed in it.
8. It is required to take precautions so that gravel, sand or asphalt do not get into the chamber during its installation

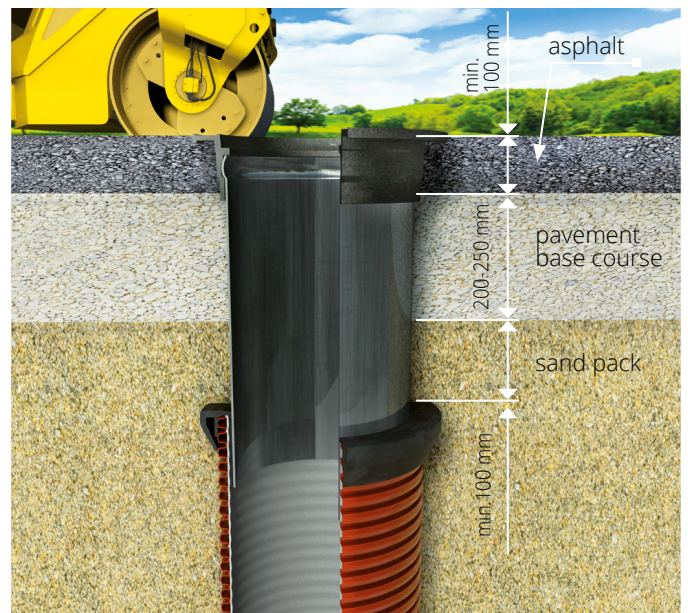

Sample setting of a T40 telescope in asphalt pavements.

Note:

The chambers must always be prepared in a way which will enable setting the manhole in the asphalt, with the min. thickness of 100 mm.

Caution must be exercised during the chamber relocation and installation, and especially when backfilling the excavations, to avoid damage to the chamber.

18.9. Installation of a chamber with a cast iron manhole and a catchment tank

The chamber consists of:

- A riser pipe with a catchment tank
- A bottom
- A telescope topped with a cast iron manhole with a cover

Chamber installation steps:

1. First, prepare the riser pipe with a catchment tank. The catchment section is created by cutting out in the chamber the inlet and outlet holes for pipelines, at an appropriate height. The chamber out-

let is placed at a height depending on the designed catchment tank capacity. In standard versions, outlet holes are placed at a height of 250 mm or 560 mm over the bottom.

2. Place a gasket in the inlet and outlet hole, and insert a proper stub pipe in the gasket (see figure on the next page). If necessary, the outlet from the chamber may be siphoned using a suitable fitting. This can be done using, e.g. two 450 mm arcs (see figure on the next page).

3. Then, cut the riser pipe to the required length.

4. Finally, close the chamber bottom with a cover.

The riser pipe closed with a bottom and cut to a suitable height, should be set rigidly on an adequately prepared ballast, by pressing, in order to fill the empty spaces under the bottom. This is followed by steps from 3 to 6, described in the section concerning the installation of a chamber with a cast iron manhole, without a catchment tank, taking account of conditions from 1 to 8 concerning the "Installation of the telescope."

A Sample structural solution for a chamber with a catchment tank $V=70 \text{ dm}^3$

B Sample solution for siphoning the outlets from chambers with a catchment tank

- 1** riser pipe with a catchment tank,
- 2** bottom,
- 3** gasket,
- 4** telescopic pipe topped with a manhole,
- 5** siphoning – two 45° elbows.



18.10. Installation of a chamber with a concrete or cast iron cover, without a catchment tank

In this case, the lower part of the chamber is made according to the principles concerning chambers with a cast iron manhole, without a catchment tank.

Steps when constructing the chamber:

1.-6. As specified in point: "Installation of chambers with a cast iron manhole, without a catchment tank."

In this case, the riser pipe should be cut to such a height that a 50 mm gap is left between its upper edge and the slope of the concrete cover.

7. Place the selected (depending on the cover type) concrete ring around the riser pipe (see figure). Make the gravel pack around the concrete ring, as necessary, compact the gravel pack properly, and level the ground surface.

8. Place a concrete or cast iron cover on the ring.

9. A chamber with a concrete cover and a catchment tank is made in a similar way.

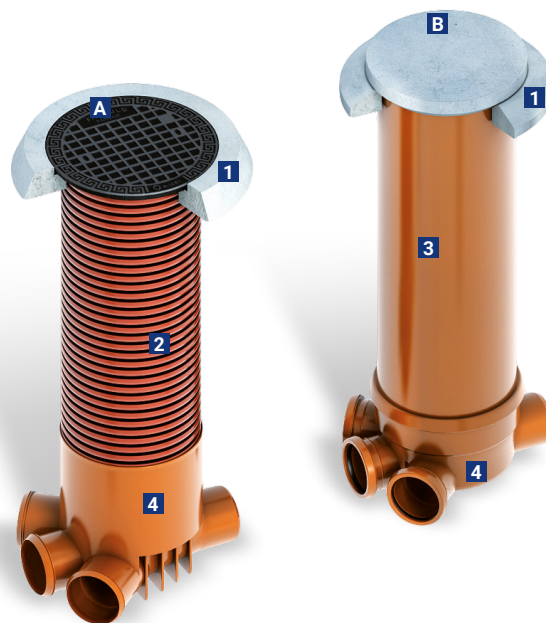

A chamber with a concrete ring and a cover:

- A** cast iron cover
- B** concrete cover

- 1** concrete ring
- 2** PP-B riser pipe
- 3** PVC-U riser pipe
- 4** PP-B chamber base

Underground drainage chamber with or without a catchment tank

The chamber consists of:

- A riser pipe
- A cover
- A bottom

Steps when constructing the chamber:

1. Prepare a riser pipe, which should be cut to the required length, and cut out inlet and outlet holes at proper levels, as required by the design.
2. Set the riser pipe (closed from the bottom) on the prepared ballast, trim thoroughly, connect the pipelines using gaskets and stub pipes.
3. Close the upper edge of the riser pipe with a cover. On the cover, place a piece of identification metal or wire, to facilitate

finding the chamber in the field in the future, using a metal detector

4. Backfill the excavation manually, up to the height of 20-25 cm above the cover level. When backfilling, make sure that the filling around the chamber is evenly laid and well compacted.

Regardless of the type of backfilled chamber, make sure that the excavation ground contains no frozen clumps and sharp-edged stones or debris.



Sample installation of an underground drainage chamber.

18.11. Joining PRO 400 chambers with sewer pipes

Pipelife chambers are perfect to be used in sewer systems made from Pragma pipes. It is facilitated by easy installation and the fact of using chamber bases made of the same material as Pragma pipes, i.e. polypropylene. Pragma pipes have their own chamber sys-

tem, equipped with branches in the form of sockets for pragma pipes. Socket stub pipes, with the DN/OD dimension, make it possible to directly connect Pragma pipes, by pressing the spigot into the socket (without a snap ring) or PVC pipe, with

the use of a gasket and a snap ring. It is also possible to use a chamber system for PVC-U smooth wall pipes. PVC-U chamber bases are equipped with sockets and spigots. Installation with Pragma pipes is thus similar to the methods presented above, respec-

Illustration of connection of Pragma system chamber bases with Pragma pipes - for pipes Ø 500 and 630 mm

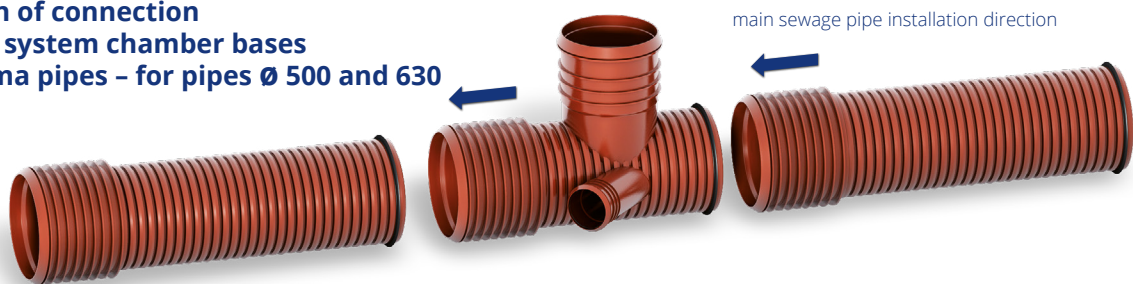

Installation of connection of PP chamber bases for PVC-U pipes with Pragma pipes

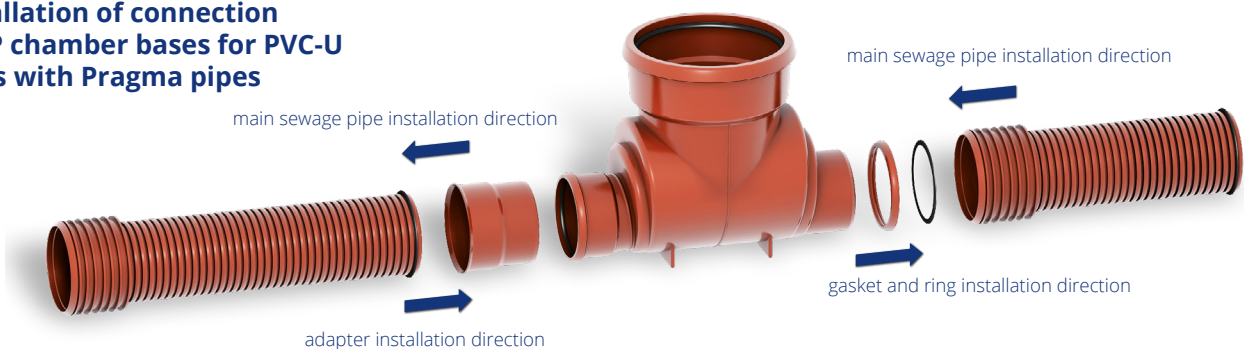

tively, for the socket and the spigot of a pipe. Such a universal character of applications lets the Designer and the Contractor change, and actually freely combine the joints of PVC-U smooth wall, PP smooth wall and Pragma pipes.

Connections of inlets/outlets terminated with sockets are intended for connecting with a

spigot of PP-B Pragma structural sewer pipe with a gasket or a smooth-wall pipe made of PVC-U, PP or PP, through a snap ring with a gasket.

Any of the pipes mentioned above can be connected in chambers for both Pragma and PVC-U pipes, thanks to the above-discussed elements.

19. PRO 630, PRO 800, PRO 1000 CHAMBERS



PRO 630 sewer chamber

The standard structure of a PRO sewer chamber, depending on the diameter, consists of the following structural elements:

- The base of the chamber, with a bottom containing a straight-through chamber base (with a straight or angular channel) or a junction chamber base (with up to 3 branches)
- The main body - the riser of the pipe made from a sewer pipe with a structural wall N 630 mm or modular ring segments with the diameter DN/ID 1000 mm or 800 mm.
- The telescope made from a smooth wall sewer pipe (or a riser pipe with a light concrete ring), or a cone reducing the diameter of the body (1000/630 or 800/630) with a manhole with the internal diameter of 630 mm, installed on modular ring segments.
- Shaped gaskets made of SBR or EPDM rubber, at the joint of the riser pipe with the base and the telescopic pipe.
- Sealing rings (gaskets) made of SBR or EPDM rubber, at the branches and the out-

let of the chamber

- The chamber top – telescopic for PRO 630 and telescopic or non-telescopic for PRO 800, 1000 (reinforced concrete load distribution ring with a DN 600 sewer manhole of class A15-D400, reinforced concrete load distribution ring 1650/1150 with a concrete chamber slab 1550/600 and a DN 600 sewer manhole, class A15-D400)

As a standard, PRO 800 and PRO 1000 chambers are equipped with a factory-installed ladder, consisting of an embedded frame and replaceable anti-slippery laddersteps made of GRP, with the width of 400 mm. Upon special request of our Customers, we provide the possibility to order a chamber with an aluminium ladder.

19.1. PRO chamber bases

The new generation PRO 630, PRO 800, PRO 1000 bases all have inlet/outlet socket stub pipes of Eurosocket type, for PVC-U smooth wall pipes, in the scope of diameters DN 160÷400 mm. The bases have a double bottom, which has made it possible to eliminate the impact of the ground water

pressure on the flow channel.

The PRO 630 base has a vertical socket for joining with the chamber riser, as well as inlet/outlet stub pipes with spigots or stub pipes terminated with sockets, for joining with the sewer system pipes, with diameters in the range of DN 160÷400 mm.

The PRO 800 and 1000 base has external ribs and a socket/flange where a gasket is placed, for connection with modular ring segments, as well as inlet/outlet stub pipes with sockets for connection with sewer system pipes with the diameters in the range of DN 160÷400 mm.

19.2. Sewer pipes connections

Smooth wall spigots are meant for joining with the sockets of PVC-U smooth wall or PP-B Pragma structural sewer pipes, with a snap ring and a gasket.

Inlet/outlet connections terminated with sockets are meant for connection with a spigot of the PP-B Pragma structural sewer pipe (with a gasket), or with a PVC-U, PE or PP pipe by means of a snap ring with a seal.

Connections with pipes made of other materials, such as cast iron, stoneware or concrete, require the use of appropriate adapters.



PRO 1000 chamber

19.3. Technical description of the chambers

- The chambers are made of PP-B polypropylene, a material with perfect mechanical, chemical and temperature resistance
- The manhole diameter in the PRO 800, PRO 1000 manhole chamber is 637 mm, the inner diameter of the body is 800 mm (PRO 800) or 1000 mm (PRO 1000)
- The PRO 800 and PRO 1000 manhole chambers have a factory mounted ladder with GRP anti-slip ladder steps
- Replaceable ladder steps or a possibility to install an aluminium ladder
- Diverse straight-through chamber bases (with a straight or an angular channel) or junction chamber bases (with up to 3 branches) with socket or spigot stub pipes
- DN 160-400 mm for PVC-U and Pragma pipes.
- All elements of the PRO chambers have ribs on the outer surface, providing appropriate nominal stiffness and very good interaction with the ground, preventing the buoyancy caused by ground waters
- Chambers can be installed down to 6.0 m below ground level
- Resistance to the pressure from groundwater (5 m water column)
- Tightness of connections up to 0.5 bar and negative pressure of 0.3 bar, as per standard EN 1277
- The chambers can be equipped with an adapter with a special structure, enabling the adjustment of the socket connection angle
- Possibility of use in load class from A15 to D400 kN, as per EN 124
- Diverse chamber tops, such as telescopes, cast iron sewer pipes with the diameter of 600 mm, class A14 – D400, according to EN 124, cast iron-concrete manholes, class B125 and D400, with the diameter of 600 mm, 1210/710 concrete cone, typical reinforced concrete rings and frames.
- Resistance of PP-B chambers to sewage complies with standard ISO/TR 10358, and that of gaskets – with IRO/TR 7620
- Possibility to make additional branches to the riser pipe or the body using in situ gas-

- kets with the diameter of 110 – 200 mm
- The chambers conform to the requirements of standards EN 13598-2, EN 476
- Technical Approvals from ITB, IBDiM, IK
- Acceptable to be used in the areas of mining damage according to GIG, for PRO 630, PRO 800 and PRO 1000
- Certificates: SKZ (Germany), SP Sverig-

- es Provnings (Sweden), KIWA (the Netherlands)
- Chamber colour RAL 8023
- Possibility of angular deviation of 4° of the 630 mm telescope in the 1000/630 or 800/630 reducer.

19.4. Additional remarks to the designs and technical specifications

The structure of the chambers meets the general structural and functional requirements stipulated in the standards: **PN-B-10729:1999** and **EN 476:2012**. The **PN-B-10729:1999** standard, concerning sewer chambers, was revoked in 2009, and has not been replaced. Therefore, it should not be invoked in designs and technical specifications.

The **EN 476:2012** standard provides general requirements for the elements used in gravity sewer systems, including sewer chambers. However, this standard is not a product standard for the manufacture of the chambers, and cannot be the basis to issue product assessments. This means that it is not allowed to issue the National Declaration of Performance, in accordance with the **EN**

476 standard. The National Declaration of Performance should invoke the **EN 13598-2** standard or the National Technical Assessments (replacing the Technical Approvals) of **ITB, IBDiM** (only for chambers not compliant with the requirements of the EN 13598-2 standard, e.g. drainage chambers)

PRO 800 and PRO 1000 manhole chambers

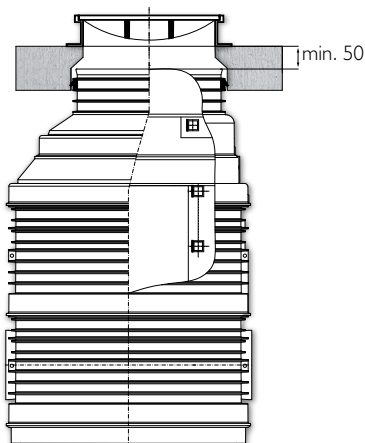

Chamber with a load distribution ring

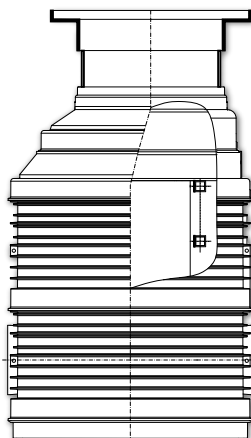

Chamber with a telescopic top

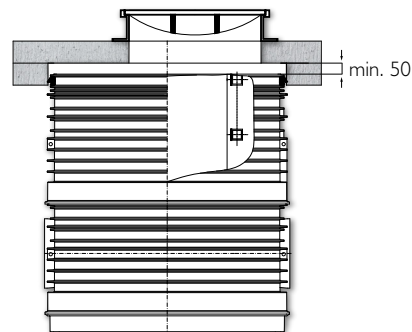

Chamber with a concrete slab

19.5. Intended use

PRO chambers are intended for external gravity (household, storm and combined) sewer systems, drainage systems, and for the installation of water meters, as well as constructing sewage pumping station tanks located in the lane of the roadway or beyond it. PRO manhole chambers facilitate conducting

maintenance, inspection and test works directly in sewer pipes. In inspection chambers, on the other hand, these works should be performed from the ground level, using specially dedicated equipment.

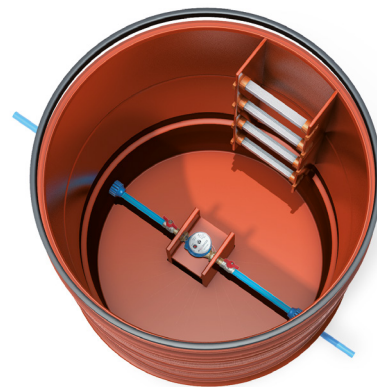

PRO 100 water meter chamber.

20. INSTALLATION OF SEWER CHAMBERS

20.1. Earthworks

If there is a need to have access to the external side of an underground structure of the sewer chamber, it is necessary to provide a minimum working space 0.50 m wide.

An open excavation for the sewer system pipes should be made in accordance with the technical conditions, as per PN-B-10736 and EN 1610, ENV 1046.

Excavation stability should be ensured by securing the excavation, shuttering the walls, and maintaining an appropriate inclination angle of the walls with scarps.

Excavations with vertical walls without shuttering can go deeper than 1m, but not deeper than 2 m, if so specified by the geological and engineering documentation.

Excavation protections should be removed as assumed in the structural design, in such a way so that it does not cause displacement of or damage to the pipe.

It is recommended that the excavated material be laid on spoil at a distance not shorter than 0.5 m from the excavation edge. The proximity and the height of the ground laid on spoil should not expose the excavation stability to any risk.

The ground material of the excavation bottom should preferably not be breached. If it is breached, its natural carrying capacity should be restored.

In ground freezing conditions, it might be

necessary to secure the excavation bottom in such a way that there are no frozen ground layers under the chamber base and the pipe, as well as around the pipe.

During installation works, the excavation should preferably be de-watered (e.g. storm water should be drained). De-watering methods should have no adverse impact on the ballast and the pipes.

Caution should be exercised during de-watering, to prevent fine ground fractions from being carried away.

Consideration should be given to the impact of de-watering on the ground water flow and the stability of the surrounding area.

For de-watering to be full, all temporary de-watering pipes should be appropriately sealed.

In a situation in which the excavation bottom carrying capacity is insufficient to provide a stable base, it is necessary to prepare special structure. This might be the case for unstable soils, such as peat or quicksand.

Examples of possible solutions in this respect include: soil replacement with other ground materials, e.g. sand, gravel, hydraulically bound materials (cement-stabilized soil, lightweight concrete).

The design should include the method of digging through the soils with various settlement-related properties.



20.2. Excavation bottom preparation

Before base preparation commences, it is required to conduct the technical acceptance of the excavation.

The appropriate chamber installation is chosen depending on the base type, its carrying capacity, the presence or absence of ground.

1. Making the base in a subsoil being intact loose soil

Subsoils can be applied as a base for the chamber, if they are loose dry soils (with normal humidity):

- Sandy soils (fine-, medium- and coarse-grained)
- Gravel and sandy soils
- Sandy and clayey soils
- Clayey and sandy soils

The chamber base should be set on a min. 10 cm thick layer of thoroughly lev-

elled, stable sand ballast, containing no stones, large ground lumps, frozen material or other sharp-edged elements. The chamber base should be levelled after setting.

The base can also be made (instead of a sorted material) of a properly prepared soil from the excavation, provided that this soil contains no large stones with the diameter above 20mm, hard lumps or debris, and that it can be properly compacted.

The base should be set horizontally on the

ballast in such a way that all spaces under the chamber base are filled with the ballast material.

Note:

The chamber bottom level is below the level of connections to the chamber base (for DN 250, 160, 200, it is 205 mm, for DN 250, 315, it is 210 mm, and for DN 400, it is 215 mm).

2. Making a reinforced base (clays, loams, low-carrying soils)

If we are dealing with an unstable excavation bottom, which is unable to provide proper support for the chamber, it is necessary to make a deeper excavation and make a foundation and a base indicated in the design, down to the required chamber installation level. This material should be compacted to at least 85% of SPD (83% in modified Proctor test).

If ground settlement is expected, it is recommended to use geotextile.

Note:

Soils containing large pieces of rocks and soils with high organic parts content, lumpy loams and muds should not be used to make the base, be it alone or in combination with other soils. In rocky excavations, it is required to lay a min. 15 cm thick layer of selected material, to provide appropriate base for the chamber.

It is unacceptable to set the chamber directly on rocks and other sharp-edged elements, as this might cause damage to the chamber base bottom

Excavation in sandy soils

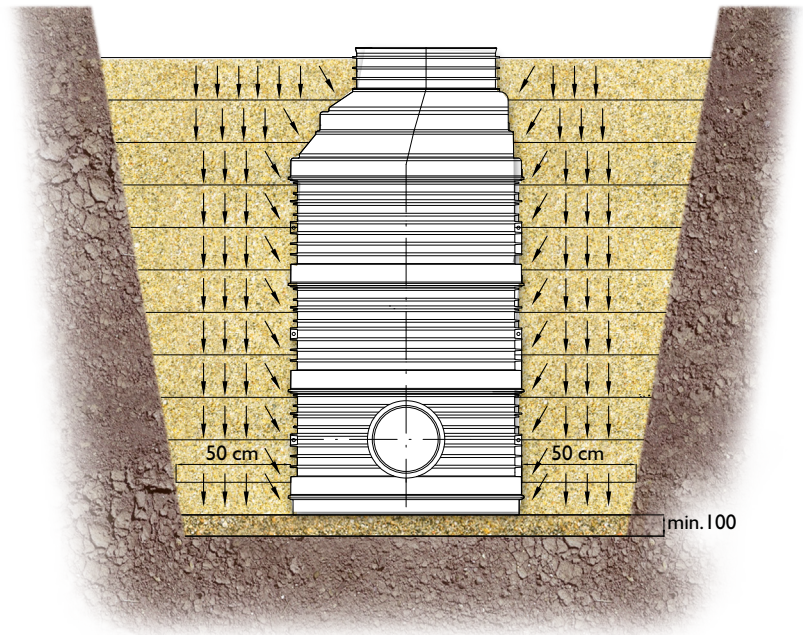

Excavation in low-carrying soils

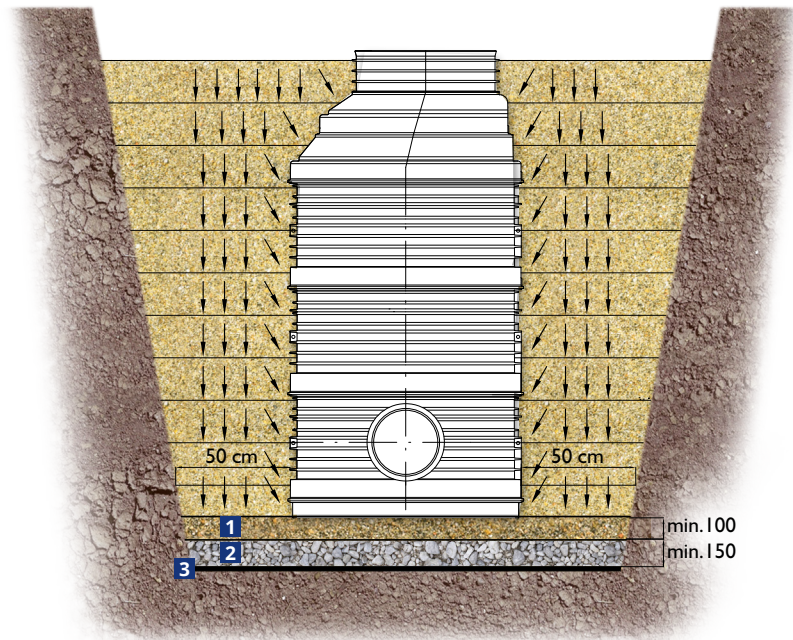

- 1 sand ballast with the min. thickness of 100 mm
- 2 gravel and sand continuous footing 1:0.3 or rubble and sand continuous footing 1:0.6 with the min. thickness of 150 mm
- 3 geofabric or concrete continuous footing

3. Presence of ground water

PRO 630, PRO 800 and PRO 1000 sewer chambers have ribbed chamber base and body walls which, in the presence of groundwater, increase the stability and decrease the buoyancy. It should be noted, however, that a drop in buoyancy depends on the type of soils used to make the gravel pack around the chamber. Therefore, it is required to use compactible G1 sandy soils with the friction angle $\phi 35^\circ$. Clayey-sandy, clayey and loamy soils of G4 type, with the friction angle $\phi 20^\circ$, 25° should not be used.

In soils with a high level of groundwater, the chamber should be protected against water buoyancy, by stabilizing its installation in the ground, e.g. by concreting the base. Especially in the case of large-diameter chambers: PRO 800, PRO 1000, and the presence of ground water above 0.5 m from the chamber bottom, verification calculations should be made.

NOTE: Upon Customer's request, Pipelife performs verification calculations

If water appears in the excavation, it should be removed using local chambers or under-

ground drainages and wellpoints. The drainage process is to be continued until the installation of the chambers, the pipes, and until backfilling is made in the excavation to a height that will protect the pipeline against rising, or the excavation against collapse. In the case of presence of ground water or loamy soil, geofabric should be used to prevent infiltration of subsoil to this zone, or displacement of the ground material from the chamber and the pipes installation zone to the subsoil. In the presence of ground water above the chamber bottom, sandy soil compaction should reach 98%-100%.

In order to fully protect the ballast and the gravel pack from soil migration, it is recommended to lay the geofabric starting from the bottom and finishing with an overlap with the width of 0.5 m over the pipe gravel pack **(A)**. This method also protects the pipes from ground settlement in the zones of diverse granulation.

In order to protect the pipe against water buoyancy, geofabric is arranged in the shape of the letter Ω **(B)**. The sides of the geofabric, at the excavation walls, should be unfolded upwards and covered with soil.

In order to protect the pipe against uneven settlement, geofabric is laid at the excavation

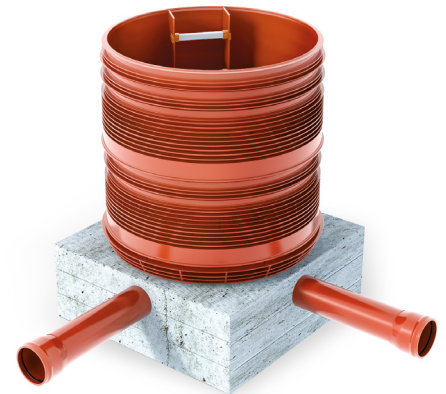

Schemat obetonowania podstawy studzienek

bottom and side walls in the ballast zone **(C)**.

The method of securing the pipe and laying gravel pack, through the arrangement of geofabric, should be selected in accordance with ENV 1046.

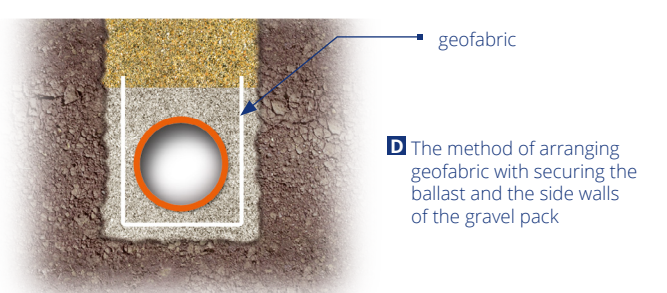
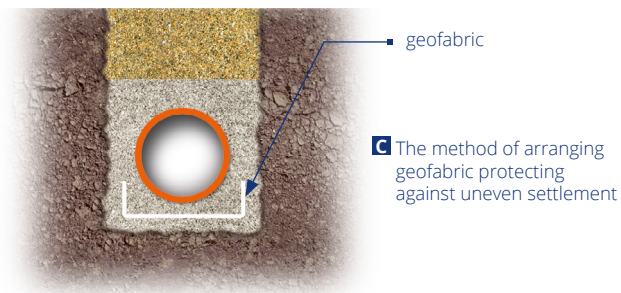
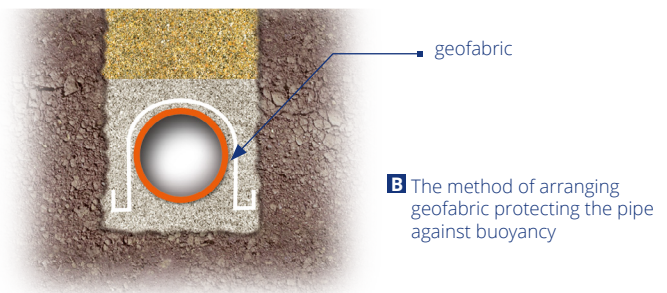
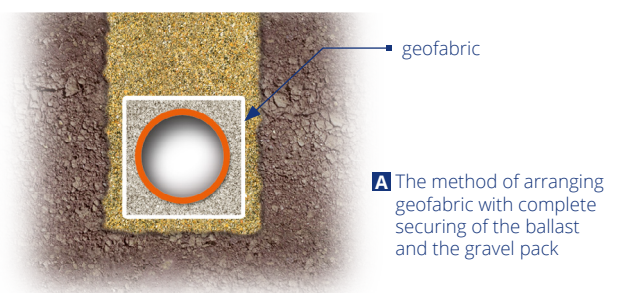

4. Mining damage areas

In the mining damage areas, socket joints should be protected against unsealing. As per the GIG guidelines, the chamber base should be covered with concrete of min. class C20/25 (former B25), accord-



ing to EN 206+A1:2016-12 (compressive strength 25 MPa), and the pouring area should reach at least 100 mm beyond a socket joint and above the connection terminals, while the minimum thickness of the concrete cover should be 100 mm. The chamber base should be joined with the

main sewage pipe with short sections of PP-B Pragma pipes or PVC-U pipes to be used for a given mining damage category.

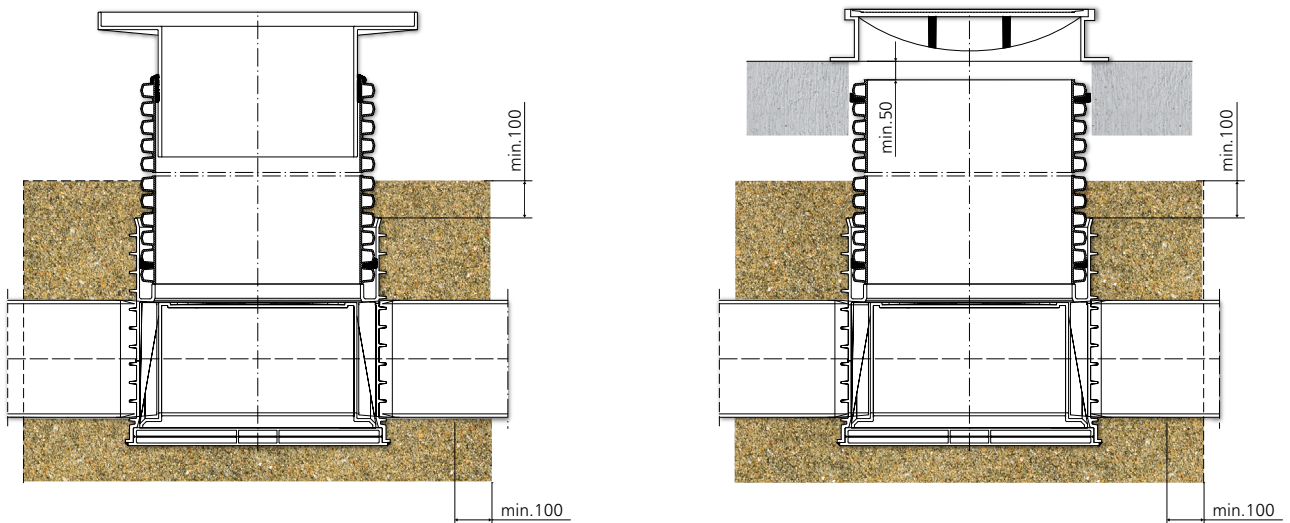
Sample illustration of concreting a PRO 630 chamber base



20.3. Installation of pipes

After setting the chamber base on the ballast, the sockets and stub pipes of the chamber base should be connected with PVC-U smooth wall sewer pipes  or PP-B Pragma structural pipes .

Before the connection is made, the gaskets should be checked for cleanliness – if they are dirty, they have to be cleaned. The pipes and the stub pipes in the chamber should be protected against the infiltration of the

ground inside it. Any dirt should be removed from the inside of the pipe and the chamber. Elastomer gaskets should be lubricated (e.g. with a silicone spray). The applied agents can contain no compounds with an adverse impact on the hardness of gaskets, e.g. hydrocarbons.

It is recommended to start laying the pipe from the lower end of the section.

When laying the pipe, the excavation bottom should be levelled to the required inclination and shape, in order to provide uniform support of the outer surface of the main part of

the pipes. Hollows for the sockets should be made in the bottom ballast or in the excavation bottom.

If works need to be interrupted for valid reasons, e.g. due to weather conditions, it is recommended to temporarily close the ends of pipes and stub pipes. It is advised not to remove any plug until the joint is made.

A Connection of PVC-U smooth wall pipes



B Connection of PP-B Pragma structural pipes

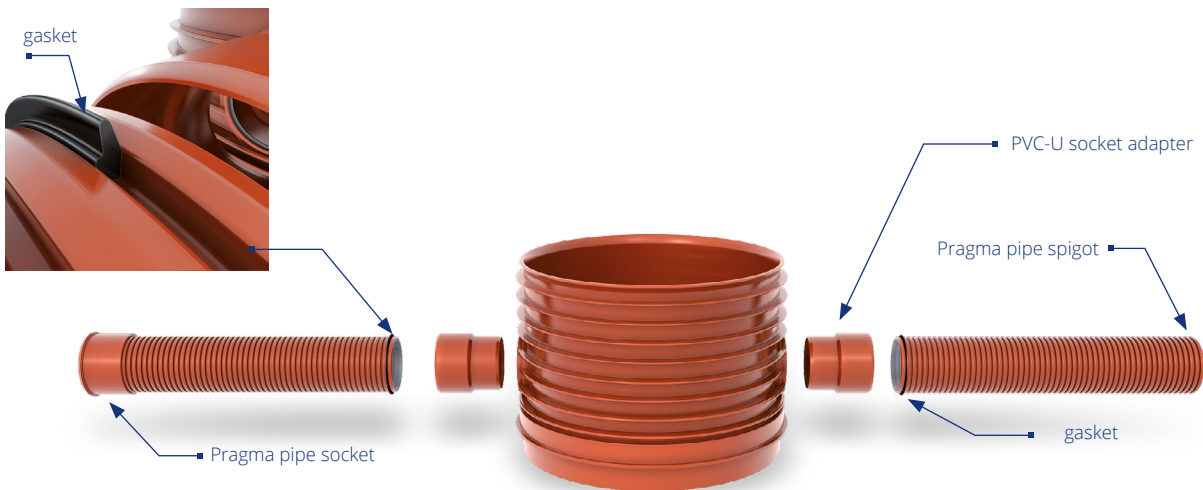

Attention should be paid to proper direction of unfolding the gasket placed on Pragma pipe

ANGLE ADAPTERS

The direction of the pipe at the junction with the base of the chambers can be altered with the use of adjustment fittings.

A new option is the possibility to use adapters with the diameter from 110 to 400 mm which, thanks to their special structure, enable changing the angle of the pipe at the junction with the chamber base.

The adapters are installed directly in the chamber base, in sockets or on spigots (connector).

Adjustment ball connector $\pm 15^\circ$

Technical properties:

- It enables changing the installation direction $\pm 15^\circ$ in any plane of the pipe, at the junction with the socket base.



Adjustment ball connector $\pm 15^\circ$

- It is made of PVC-U with the diameters dn from 110 mm to 250 mm (spigot/socket version), and 160 mm, 200 mm (socket/socket version).
- The ball socket has a lip gasket or an oil-proof gasket with a PP ring.
- Colour: orange-and-brown.



Connection of PVC-U smooth wall pipes

20.4. Making an extension

The PRO 630 chambers are extended by mounting a PP-B structural riser pipe with the diameter of 630 mm, with a gasket placed below the first knurl in the chamber base socket. Standard lengths of a riser pipe are 2 and 6 m.

The riser pipe may be trimmed to the required height, in the 5 cm intervals. The riser of PRO 630 chambers is one section of the pipe.

PRO 800 and PRO 1000 pipes are extended by mounting, on the chamber base, modu-

lar ring segments of appropriate height. The standard segments are available with the heights of 0.5; 1.0 and 1.5 m.

PRO 800, PRO 1000 chamber body rings

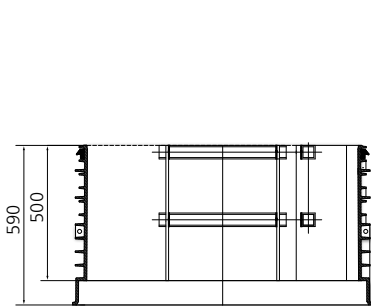

H = 0.5 m

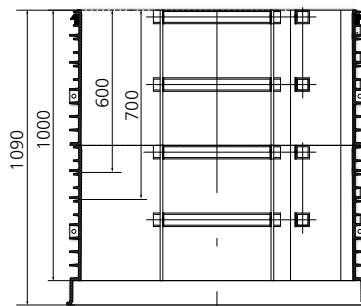

H = 1.0 m

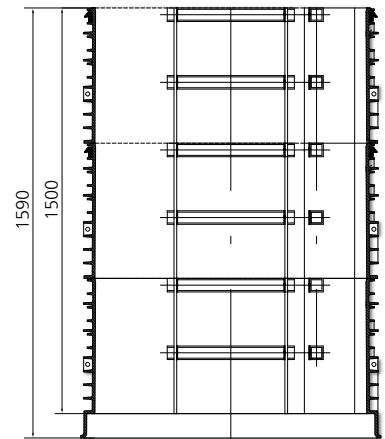

H = 1.5 m

PRO 1000 (800) segments have a factory-mounted ladder with steps. When adding consecutive rings, they should be arranged in such a way that the ladder steps are aligned – one above the other.

Before the gasket for PRO 800 and PRO 1000 chambers is placed at the top part of the chamber base, the gasket and the space meant for it should be cleaned. Before making the connection, all the gaskets should be lubricated.

The required riser height of PRO 800 and

PRO 1000 chambers is achieved by using an appropriate number of segments and trimming the segments by 100 mm or 200 mm, as well as trimming the 1000/630 or 800/630 cone by max. 10 cm.

Trimming should preferably be done using a chainsaw. After trimming, the ring and the reducer should be cleaned from the material remnants. It is possible to make additional inlets/branches to the chamber riser, using in situ gaskets with the diameter in the range DN 110-315.

The EN 476 standard admits manhole chambers with the nominal inner diameter DN/ID

800 and the max. depth of 3 cm, for sporadic entry by a person equipped with a harness, to inspect the cleaning, inspection and test equipment.

The working height of a sewer chamber should not be lower than 2 m; the height of 1.8 m is acceptable, if required by the sewer depth and the landform.

PRO 800, PRO 1000 chamber body ring

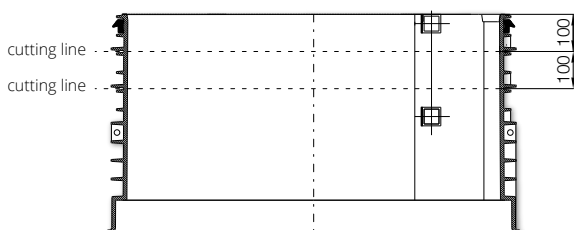

Reducers

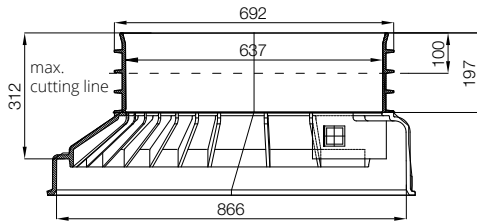

Reducer 800/630

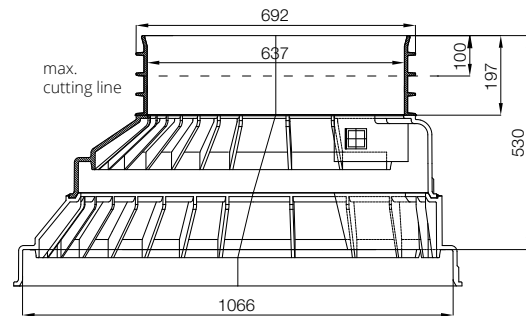

Reducer 1000/630

20.5. Installation of the top

PRO 630 inspection chambers may be topped by:

1. A telescopic pipe with a reinforced concrete ring, and a cast iron or cast iron-concrete manhole, class A15-D400, according to EN 124,
2. Reinforced concrete load distribution ring 1150/650 mm, with a cast iron manhole, class A15-D400.

Example of a telescopic top for PRO 630 chamber

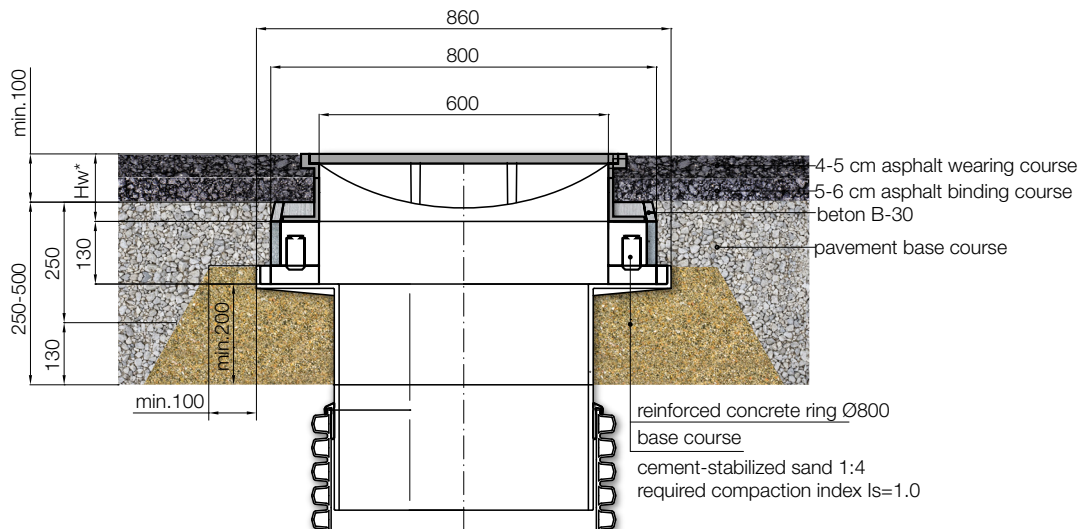

*) the dimension should be adapted to the height of the sewer manhole used

Example of a PRO 630 chamber top with a reinforced concrete load distribution ring 1150/650 mm

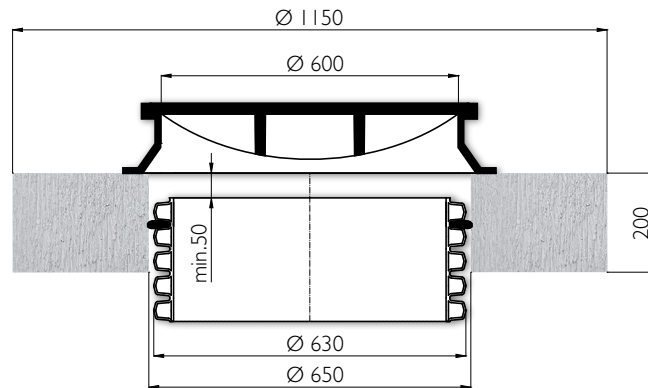

A base course can be made of a cement-stabilized sand 1:4 or a compacted soil in a road pavement up to 100% of Proctor index. The top is to be installed in accordance with the design.

PRO 800 and PRO 1000 chambers can be topped by:

1. A reinforced concrete cone with the min. inner diameter of 710 mm, with a sewer manhole DN 600, class A15-D400
2. A reinforced concrete load distribution ring, e.g. 1650/1150 with a reinforced concrete slab 1550/600 and a sewer manhole DN 600, class A15-D400.

Example of a PRO 800, PRO 100 chamber top

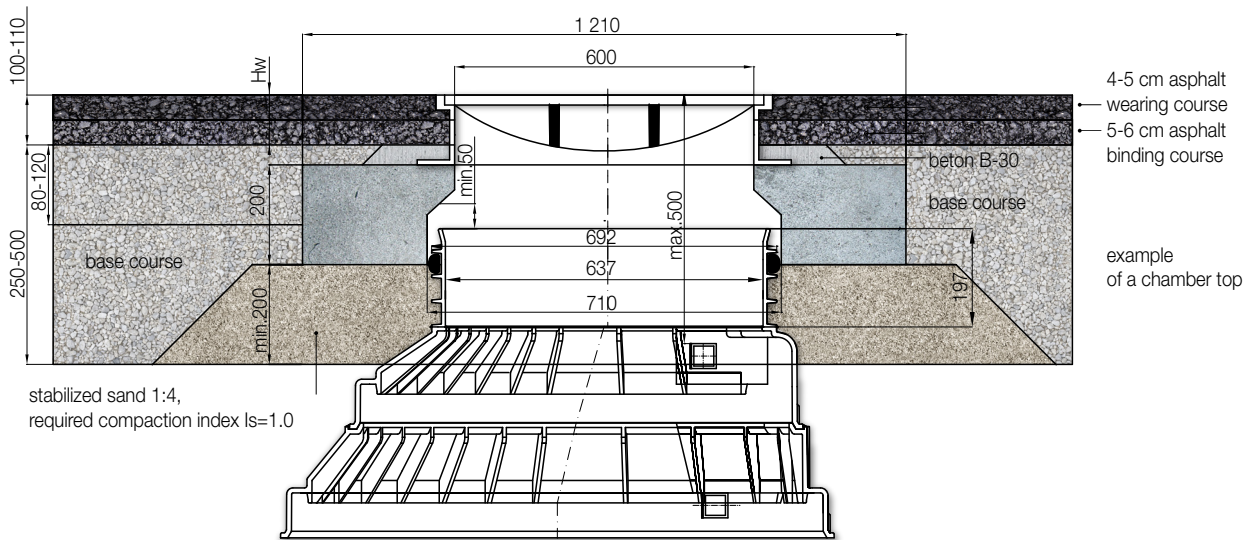

Note:

A reinforced concrete slab with a cast iron top should be separated from the upper part of the chamber with a structural joint, with the min. width of 5 cm.

The cast iron manhole should always be secured against shifting during further works, by concreting on the reinforced concrete ring or anchoring.

According to standard EN 13598-2, the maximum distance from a step to the cast iron cover top is 0.5 m. According to standard EN 476, the maximum height of the upper part of the cone with the inner diameter DN/ID 600 mm is 0.45 m.

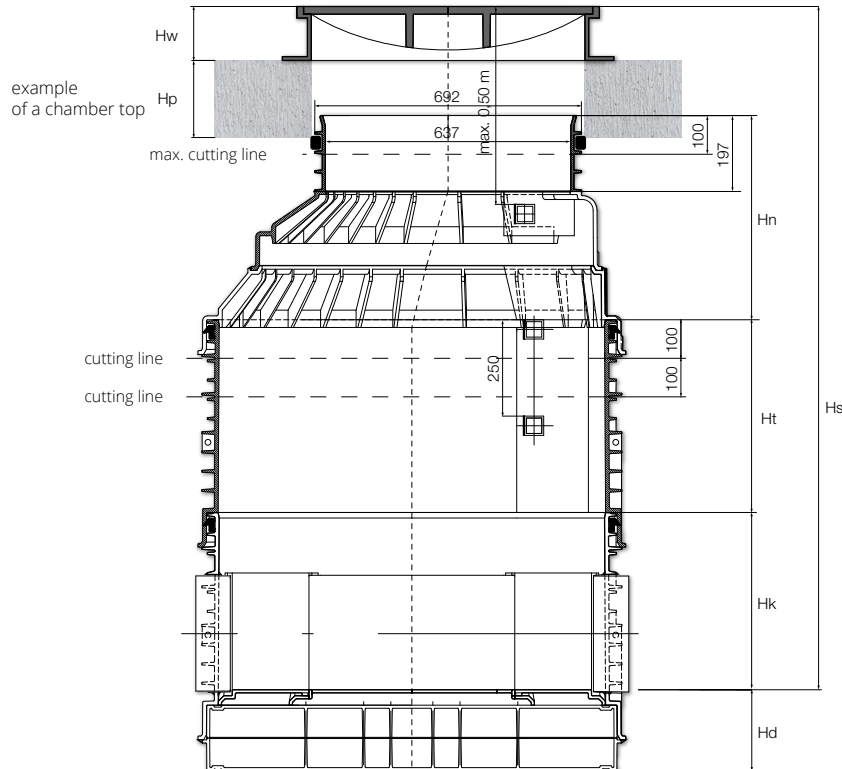

Heights of PRO 800, 1000 chamber elements

DN	Hd	Hk	Ht	Hn	
				PRO 1000	PRO 800
[mm]	[mm]	[mm]	[mm]	[mm]	[mm]
160, 200	0.205	0.465	0.5; 1.0; 1.5 or their sum	0.53	0.42
250, 315	0.210	0.460			
400	0.215	0.455			

Hk useful height of the chamber base, depending on the diameter
Ht useful height of the body ring, as a standard: 0.5, 1.0; 1.5 or their sum
Hn height of the cone, depending on the type
Hd height depending on the chamber base type

Hp height of the reinforced concrete load distribution ring, depending on height
H height of the manhole, depending on the type
Hs useful height of the chamber

PRO 1000 OSB chamber with a telescope

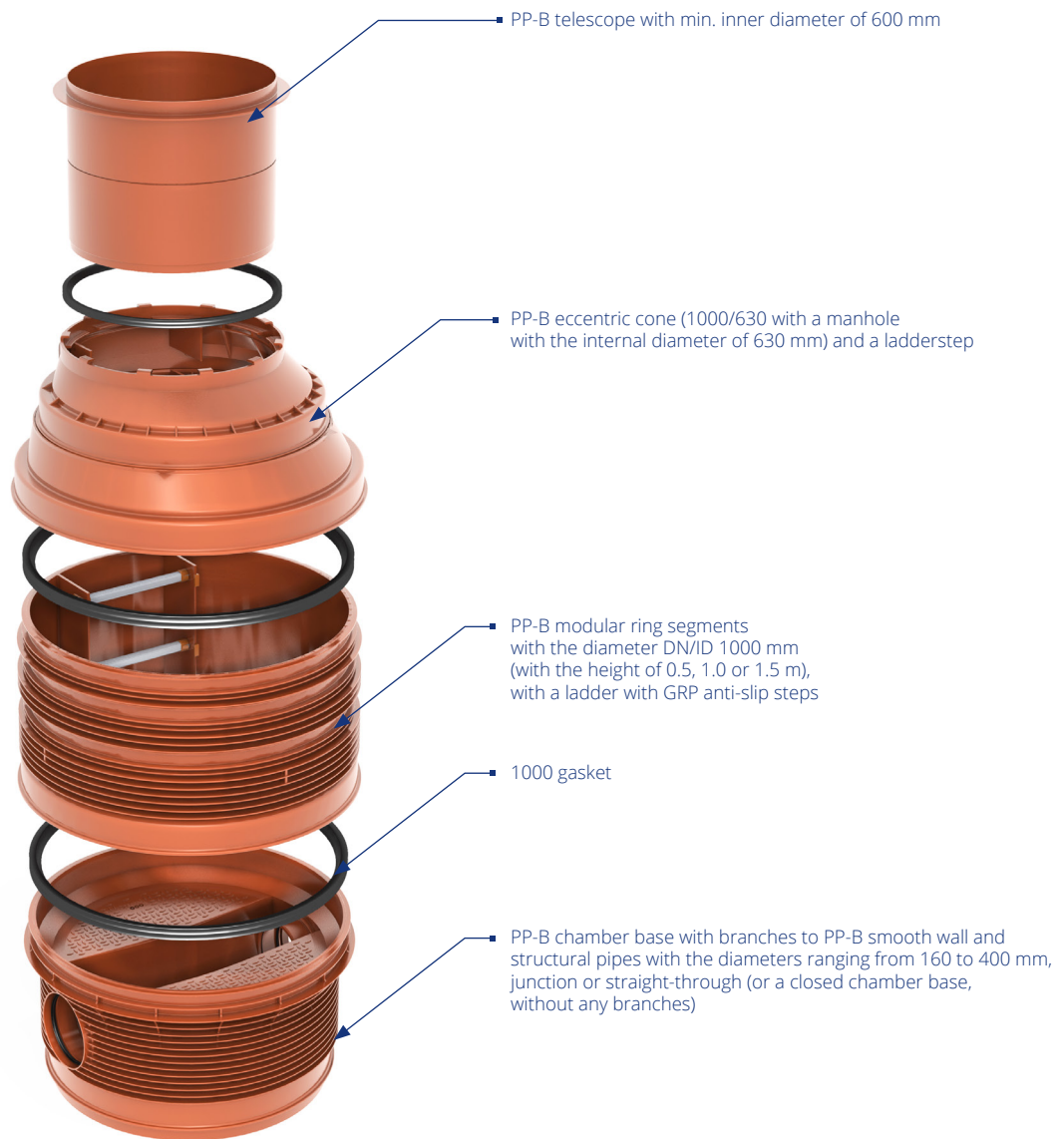

20.6. Cascade chambers

For PRO 630 inspection chambers with the pipes diameter of 160, 200 mm, connection to the chamber can be made above the chamber base bottom, directly to the riser pipe DN 630, using an in situ gasket, without a pitch pipe.

For inspection sewer chambers with the pipes diameter above 200 mm, connection to the chamber should be made using a pitch pipe outside the chamber at an angle of 90° or 45°, connected

to the chamber bases. The pipe section between the tee pipe and the chamber after reduction in the diameter to DN 200 mm is joined with the chamber riser using an in situ gasket.

Cascade chambers on sewers with the diameters up to 0.4 m and the pitch height from 0.5 m to 4 m can be made with a pitch in a vertical pipe, placed outside the chamber

Examples of solutions of cascade chambers are shown in the figure below. For PRO 630 inspection sewer chambers with the pipes diameter

of 160, 200 mm, connection to the chamber can be made above the chamber base bottom, directly to the riser pipe DN 630 mm, using an in situ seal, without a pitch pipe.

It is recommended to concrete the vertical pitch pipe.

For PRO 1000 manhole sewer chambers with the inner diameter DN/ID 1000 mm, connection should be made with a pitch pipe placed outside or inside the chamber.

Connection to the riser pipe and the body rings should be made using in situ lip gaskets.

Examples of solutions for PRO 630 cascade chambers



Making an in situ branch to PRO 800, 1000 chambers

In PRO 800, 1000 chambers, the hole should be cut out with a fretsaw, from the inside of the body ring. The hole cannot be located in the socket part of the ring and at the connection point between rings. The hole diameter should be adapted to that of the in situ gasket. After removing jagged edges from the hole, install the in situ gasket. Lubricate the gasket, and then insert the spigot of a smooth wall pipe or a fitting.

Bibliography

EN 13476-1:2008 Plastics piping systems for non-pressure underground drainage and sewerage - Structured-wall piping systems of unplasticized poly(vinyl chloride) (PVC-U), polypropylene (PP) and polyethylene (PE) - Part 1: General requirements and performance characteristics

EN 14654-1:2014-07 Management and control of operational activities in drain and sewer systems outside buildings - Part 1: Cleaning



21. INSTALLATION INSTRUCTION



1. Prepare the bedding material, as well as the supporting area of the shaft floor according to the DIN EN 1610. The surface must be level and stable. This is created by compacting an approx. 10 cm thick layer.



2. Align the multiple lip seal with the lip to the bottom, and place them in the top seal groove. Check the sealing element for damage and proper fit.

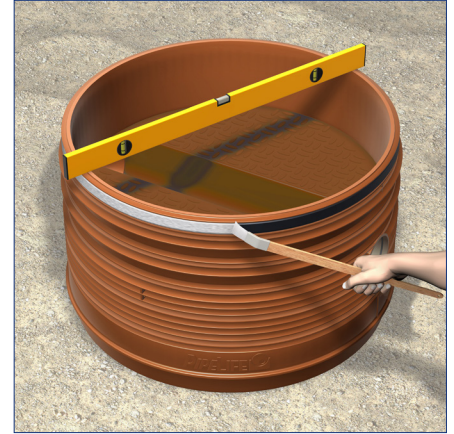

3. Align the bottom of the riser, and lubricate the multiple lip seal evenly. Before you connect the pipe to the base, check if the connection seals are clean. Lubricate the sockets for the pipe connection.

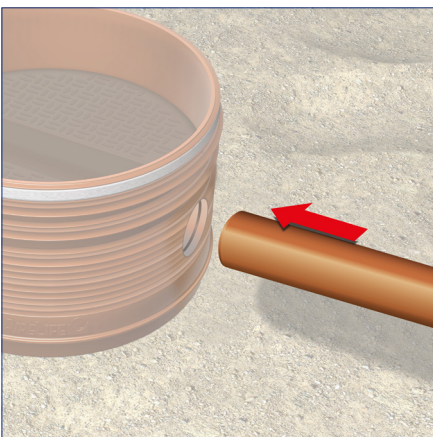

4. Push the connecting pipes up to the stop in the sockets.

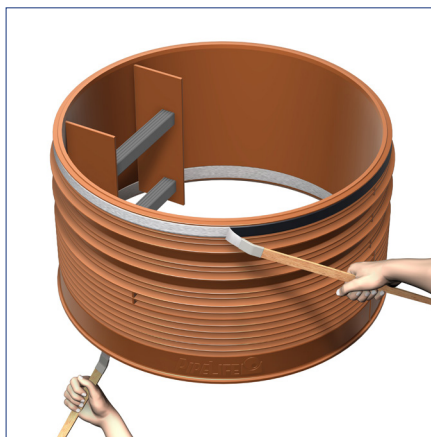

5. Lubricate now the multiple lip seal and the socket part of the riser ring evenly.



6. Place the riser ring up to the stop on the base of the manhole.

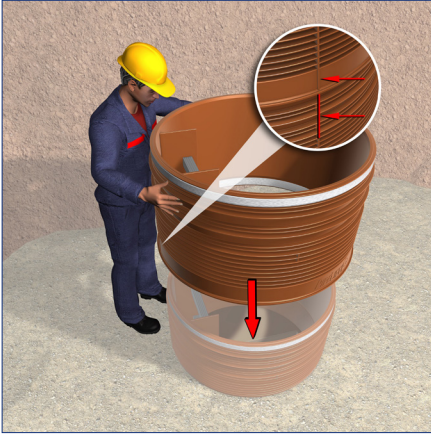

7. Finally, align the rungs on the basis of the rib on the outside. Now the first manhole ring sits. Further rings should be placed analogous to the steps 6 to 7.



8. Fill the pit with backfilling material G1 or G2. With round grains of which the maximum size should be 32mm. With broken material, do not exceed 16 mm. Compact layers in 20 to 40 cm thick layers according to EN DIN IN 1610, ATV DVWK STANDARD A 139. In the road sector is a compression ratio of at least $DPr =$ to reach 97%.

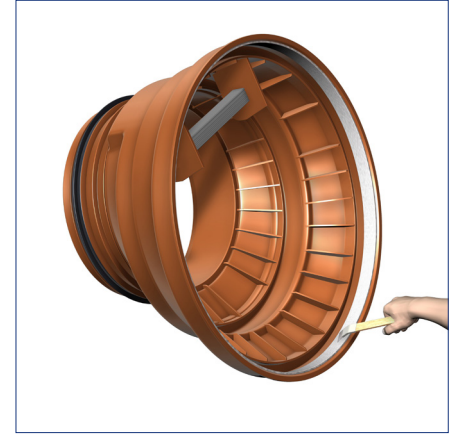

9. Lubricate the socket of the cone evenly.



10. Install the cone until it stops on the riser ring. Then, cover the cone with construction protection.



11. The installation of the Pipelife manhole is now ready and can now analog to point 9, be further filled and compacted.

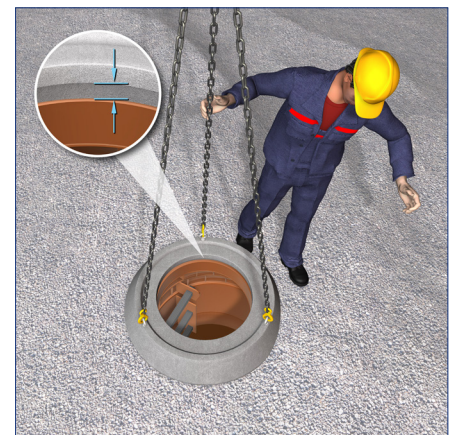

12. Place the concrete support ring centrally. Between the top of the entrance of the cone and the support ring must remain a gap of approx. 4 cm., than the traffic load will not be transferred directly to the chamber system, but will be redirected, as intended, at the roadbed.

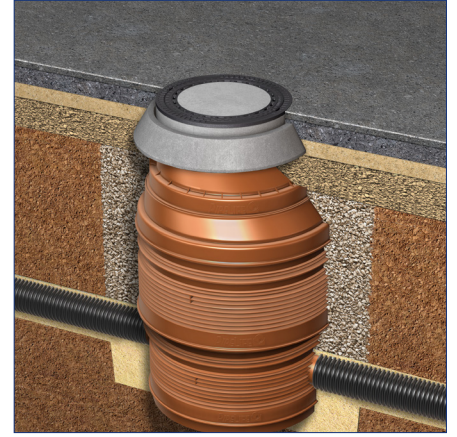
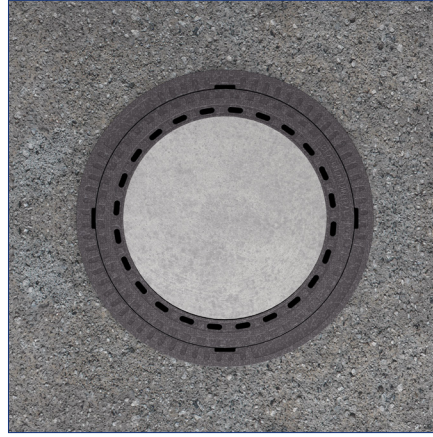
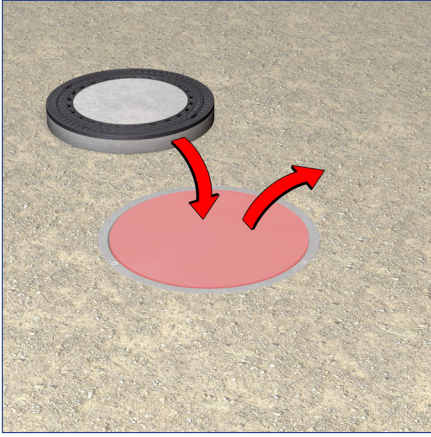

13. Now fill the pit up to the upper edge of the ground as before to EN DIN 1610. Before you apply the road surface, please remove the construction protection cover and put the corresponding cover on the support ring.

14. Using concrete compensation rings you can customize the height (in accordance with the entry level of 650 mm from the ground level to the top rung) at the street level. Sticking out or lowering of the self-supporting cover from the street can be avoided.

22. PRODUCT RANGE

PRO 200

PRO 200 SEWER CHAMBERS

Smooth wall pipe chambers with a smooth wall riser pipe

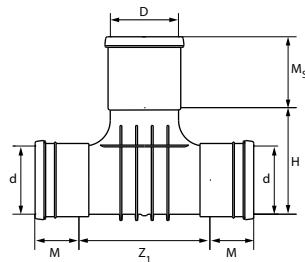

PP-B PRO 200 straight-through base for smooth wall pipes with a smooth riser pipe					
d [mm]	D [mm]	M [mm]	Z ₁ [mm]	M _s [mm]	H [mm]
110	200	68	361	208	222
160	200	82	512		315
200	200	130	386		313

Sockets have factory fitted gaskets

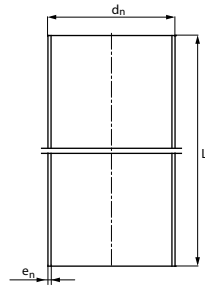

PVC-U riser pipe			
d _n [mm]	e [mm]	L [m]	SN [kN/m ²]
200	4.9	2.0; 6.0	4

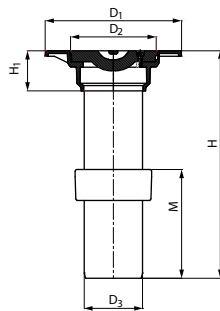

T20 telescope with a cast iron cover								
Type	Class [kN]	Size [mm]	D ₁ [mm]	D ₂ [mm]	D ₃ [mm]	H ₁ [mm]	H [mm]	M [mm]
T20	400	374	374	235	160	110	910	200

Telescopic pipe connection is integrated with the cast iron body. The manhole cover is installed using an M10 screw. The telescope contains a gasket for 200 mm PVC-U riser pipe.

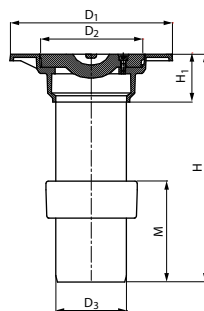

T05 telescope with a cast iron cover								
Type	Class [kN]	Size [mm]	D ₁ [mm]	D ₂ [mm]	D ₃ [mm]	H ₁ [mm]	H [mm]	M [mm]
T05 D	15	327	327	212	160	60	500	200

The telescope contains a gasket for 200 mm PVC-U riser pipe

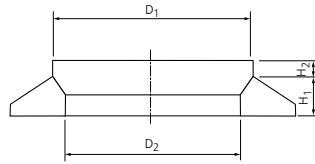

Reinforced concrete cone with a cover					
d ₀ [mm]	D ₁ [mm]	D ₂ [mm]	D ₁ [mm]	H ₂ [mm]	Class [kN]
200	420	220	80	60	70

PRO 315

PRO 315 SEWER CHAMBERS

PVC-U pipe chambers with a PP-B structural riser pipe

The PRO 315 base has branch/outlet sockets with gaskets for PVC-U pipes. Pragma pipes are to be joined using adapters.

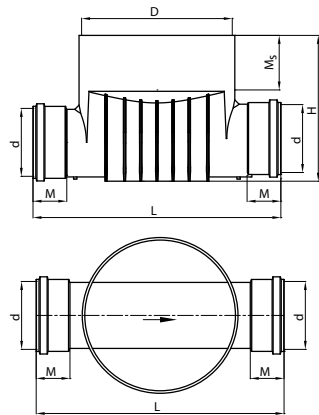

PP-B PRO 315 straight-through base for smooth wall pipes with a PP-B structural riser pipe					
d [mm]	D [mm]	M _s [mm]	H [mm]	M [mm]	L [mm]
160	355	128	344	80	584
200			384	86	620

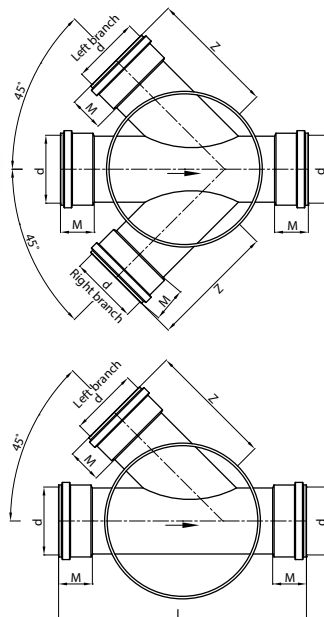

PP-B PRO 315 junction base for smooth wall pipes with a PP-B structural riser pipe						
d [mm]	D [mm]	M _s [mm]	H [mm]	M [mm]	L [mm]	Z [mm]
160	355	128	344	80	584	295
200			384	86	620	313

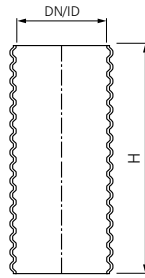

PP-B single wall riser pipe				
DN/ID [mm]	d_{min} [mm]	d_{em} [mm]	H [mm]	SN [kN/m ²]
315	318.1	351.8	6000	4
	319.4		6000	2
			3000	
			2000	
			1250	

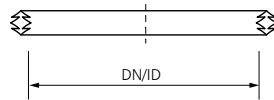

Gasket for a PP-B riser pipe and a telescope
DN/ID [mm]
315

Gasket installed outside the riser pipe, for connection with the chamber base
 Gasket installed inside the riser pipe, for connection with the telescopic pipe

PRO 400

PRO 400 SEWER CHAMBERS

PVC-U pipe chambers with a PP-B structural riser pipe

The PRO 400 base has branch/outlet sockets with gaskets for PVC-U pipes. Pragma pipes are to be joined using adapters.

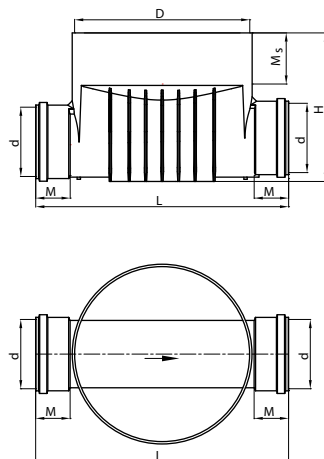

PRO 400 straight-through base for smooth wall pipes with a PP-B structural riser pipe					
d [mm]	D [mm]	M_s [mm]	M [mm]	H [mm]	L [mm]
160	404	155	80	343	584
200			86	384	620

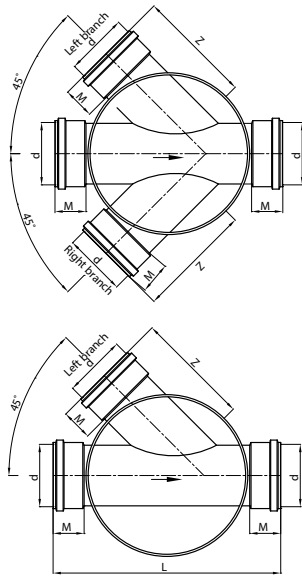

PRO 400 junction base for smooth wall pipes with a PP-B structural riser pipe

d [mm]	D [mm]	M _s [mm]	M [mm]	H [mm]	L [mm]	Z [mm]
160	404	118	80	344	584	295
200			86	384	620	313

Pragma pipe chambers with a PP-B structural riser pipe

The PRO 400 pragma base has sockets for Pragma pipes. Connection of PVC-U pipe with a socket should be made using a ring with a gasket

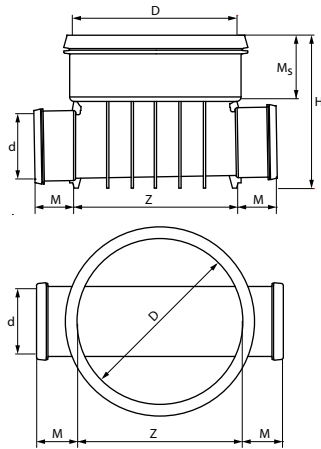

PRO 400 straight-through Pragma base for Pragma pipes with a PP-B structural riser pipe

d [mm]	D [mm]	M _s [mm]	H [mm]	M [mm]	Z [mm]
160	400	155	373	94	403
200			415	112	402

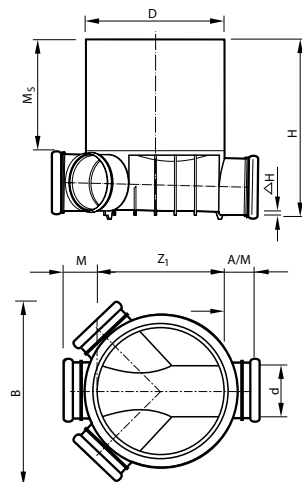

PRO 400 junction Pragma base for Pragma pipes with a PP-B structural riser pipe

d [mm]	D [mm]	M [mm]	M _s [mm]	B [mm]	A [mm]	Z ₁ [mm]	H [mm]
160	400	100	325	550	-	268	536
200	400	116	328	670	-	233	580
200	400	130	310	1000	135	585	785

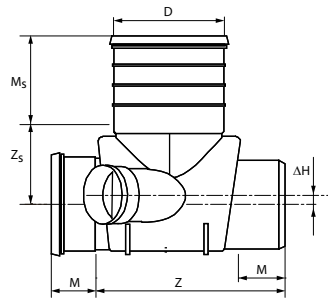
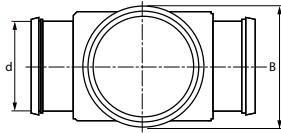
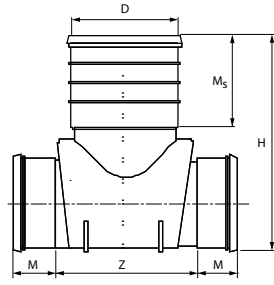

PRO 400 straight-through Pragma base for Pragma pipes with a PP-B structural riser pipe

d [mm]	D [mm]	H [mm]	B [mm]	Z [mm]	M [mm]	Ms [mm]
250	400	758	460	585	130	310
315	400	790	460	545	138	310
400	400	800	460	509	150	310

PRO 400 junction Pragma base for Pragma pipes with a PP-B structural riser pipe

d _n [mm]	d [mm]	M [mm]	Ms [mm]	Z [mm]	A [mm]	Z _s [mm]	ΔH [mm]
250	110	130	310	720	135	328	75
250	160	130	310	720	135	328	75
250	200	130	310	720	135	328	75
250	250	130	310	720	135	328	75
315	110	138	310	702	155	298	43
315	160	138	310	702	155	298	43
315	200	138	310	702	155	298	43
315	250	138	310	702	155	298	0
315	315	138	310	702	155	298	43
400	110	150	310	680	176	258	0
400	160	150	310	680	176	258	0
400	200	150	310	680	176	258	0
400	250	150	310	680	176	258	0
400	315	150	310	680	176	258	0

- 1) Before placing an order, the possibility of making appropriate combinations of additional branches should be checked with the Customer Service Department.
- 2) Other options should be checked with the Customer Service Department in advance.

* Made only with the 90° angle

NOTE: Pragma 1D structural pipes with the diameter of 300 and 400 mm can be joined with the chamber socket to a smooth wall pipe using an adapter ID/OD 300/315 mm and 400/400 mm. When joining the chamber base with a Pragma socket, it is also necessary to use a snap ring with a gasket.

Combination of additional inlets and bases

straight-through base	diameter of additional inlets						
	110	160	200	250	315	400	500
400/250	+	+	+	+	-	-	-
400/315	+	+	+	+	+	-	-
400/400	+	+	+	+	+	+*	-
400/500	+	+	+	+	+	+*	-
400/630	+	+	+	+	+	+	+*

configurations of junction bases

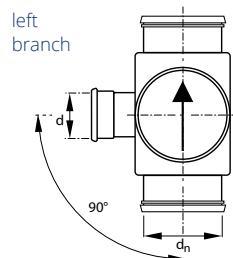
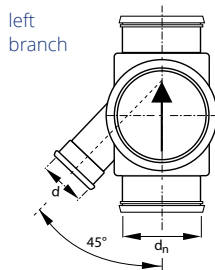

double branch

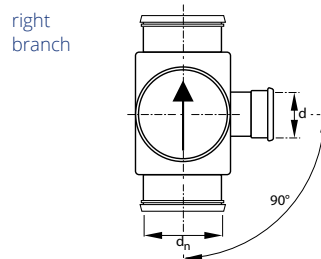
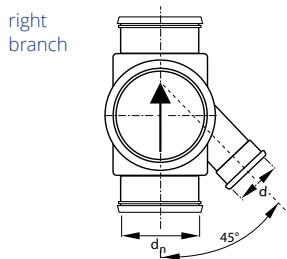
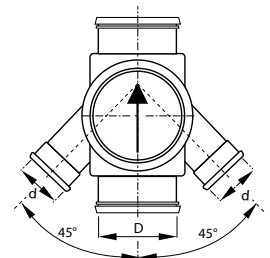

double branch with any angle and diameter combination

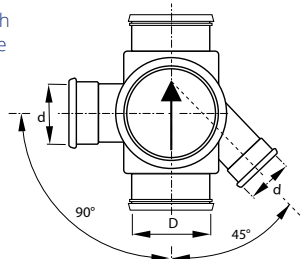

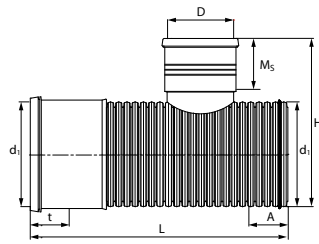

PRO 400 straight-through base for Pragma pipes with a PP-B structural riser pipe

d_1 [mm]	D [mm]	M_s [mm]	H [mm]	t [mm]	A [mm]	L [mm]
500	400	310	912	188	225	1035
630	400	310	1050	232	296	1222

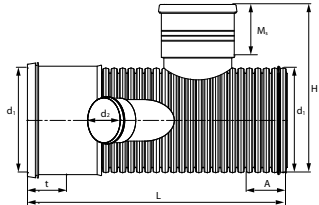

PRO 400 junction base for Pragma pipes with a PP-B structural riser pipe

d_1 [mm]	d_2 [mm]	α [°]	D [mm]	M_s [mm]	H [mm]	t [mm]	A [mm]	L [mm]
500	160	45.90	400	310	894	188	225	1035
	200							
	250							
	315							
400	90							
630	160	45.90	400	310	1025	232	296	1222
	200							
	250							
	315							
	400	90						
500	90							

Pragma*ID pipe chambers with a PP-B structural riser pipe

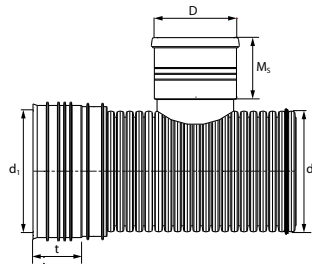

PRO 400 straight-through base for Pragma*ID pipes with a PP-B riser pipe

d_1 [mm]	D [mm]	M_s [mm]	t [mm]
500	400	310	170
600			197
800			247

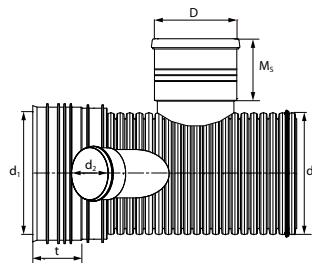

PRO 400 junction base for Pragma*ID pipes with a PP-B riser pipe

d_1 [mm]	d_2 [mm]	α [°]	D [mm]	M_s [mm]	H [mm]
500	300	45.90	400	310	170
	400				
600	300	45.90	400	310	197
	400				
800	300	45.90	400	310	247
	400				

1) Before placing an order, the possibility of making appropriate combinations of additional branches should be agreed with the Customer Service Department.
 2) Other options should be previously agreed with the Customer Service Department.

Smooth wall pipe chambers with a PP-B structural riser pipe

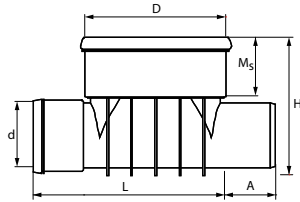

PRO 400 straight-through base for smooth wall pipes with a PP-B structural riser pipe

d [mm]	D [mm]	L [mm]	H [mm]	M _s [mm]	A [mm]
160	400	603	383	165	100
200	400	634	423	165	116

Sockets have factory mounted gaskets

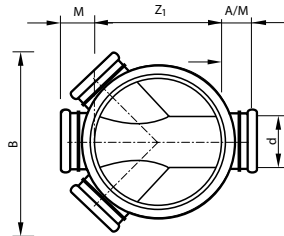
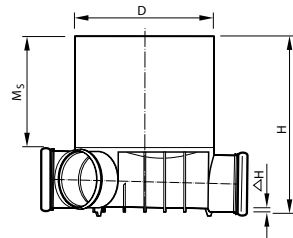

PRO 400 junction base for smooth wall pipes with a PP-B structural riser pipe

d [mm]	D [mm]	M [mm]	M _s [mm]	B [mm]	A [mm]	Z ₁ [mm]	H [mm]
160	400	100	325	550	-	268	536
200	400	116	328	670	-	233	580
250	400	130	310	1000	135	585	785

Sockets have factory mounted gaskets

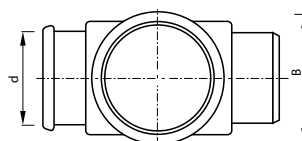
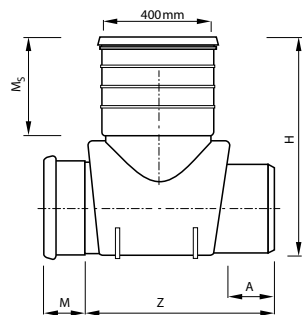

PRO 400 straight-through base for smooth wall pipes with a PP-B structural riser pipe

d [mm]	H [mm]	B [mm]	Z [mm]	M [mm]	M _s [mm]	A [mm]
250	785	460	720	130	310	135
315	790	460	700	138	310	155
400	800	460	685	150	310	176

Sockets have factory mounted gaskets

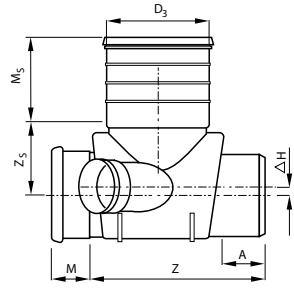

PRO 400 junction base for smooth wall pipes with a PP-B structural riser pipe

d _n [mm]	d [mm]	M [mm]	M _s [mm]	Z [mm]	A [mm]	Z _s [mm]	ΔH [mm]
250	110	130	310	720	135	328	75
250	160	130	310	720	135	328	75
250	200	130	310	720	135	328	75
250	250	130	310	720	135	328	75
315	110	138	310	702	155	298	43
315	160	138	310	702	155	298	43
315	200	138	310	702	155	298	43
315	250	138	310	702	155	298	0
315	315	138	310	702	155	298	43
400	110	150	310	680	176	258	0
400	160	150	310	680	176	258	0
400	200	150	310	680	176	258	0
400	250	150	310	680	176	258	0
400	315	150	310	680	176	258	0

Sockets have factory mounted gaskets
Other chamber base configurations are available upon Customer request.

configurations of junction bases

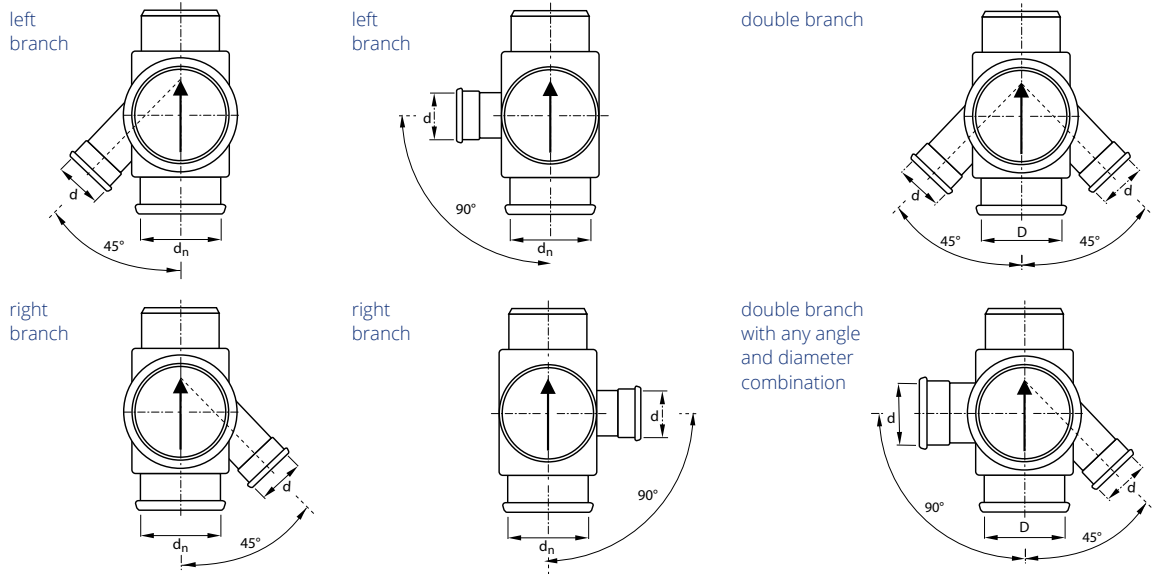

Pragma structural pipe chambers with a smooth wall riser pipe

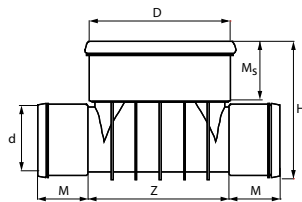

PRO 400 straight-through base for Pragma structural pipes with a smooth wall riser pipe

d [mm]	D [mm]	H [mm]	B [mm]	Z [mm]	M [mm]	M _s [mm]
160	400	375	460	600	97	157
200	400	415	460	400	112	157

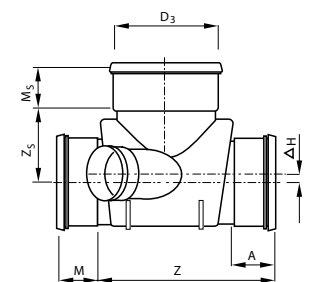
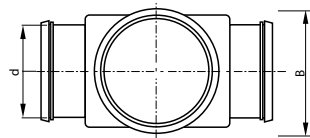
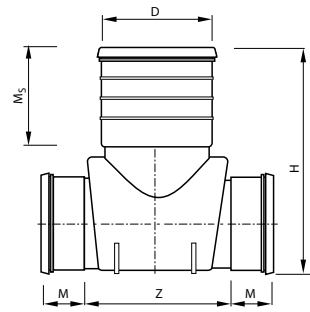

PRO 400 straight-through base for Pragma structural pipes with a smooth wall riser pipe

d [mm]	D [mm]	H [mm]	B [mm]	Z [mm]	M [mm]	Ms [mm]
250	400	785	460	585	130	310
315	400	790	460	545	138	310
400	400	800	460	509	150	310

PRO 400 junction base for Pragma structural pipes with a smooth wall riser pipe

d _n [mm]	d [mm]	M [mm]	Ms [mm]	Z [mm]	A [mm]	Z _s [mm]	ΔH [mm]
250	110	130	150	720	135	328	75
250	160	130	150	720	135	328	75
250	200	130	150	720	135	328	75
250	250	130	150	720	135	328	75
315	110	138	150	702	155	298	43
315	160	138	150	702	155	298	43
315	200	138	150	702	155	298	43
315	250	138	150	702	155	298	0
315	315	138	150	702	155	298	43
400	110	150	150	680	176	258	0
400	160	150	150	680	176	258	0
400	200	150	150	680	176	258	0
400	250	150	150	680	176	258	0
400	315	150	150	680	176	258	0

Combination of additional inlets and bases

straight-through base	diameter of additional inlets						
	110	160	200	250	315	400	500
400/250	+	+	+	+	-	-	-
400/315	+	+	+	+	+	-	-
400/400	+	+	+	+	+	+*	-
400/500	+	+	+	+	+	+*	-
400/630	+	+	+	+	+	+	+*

1) Before placing an order, the possibility of making appropriate combinations of additional branches should be checked with the Customer Service Department.
 2) Other options should be checked with the Customer Service Department in advance.

* Made only with the 90° angle

configurations of junction bases

left branch

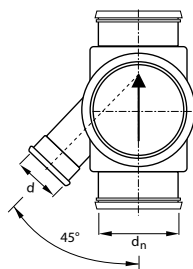

left branch

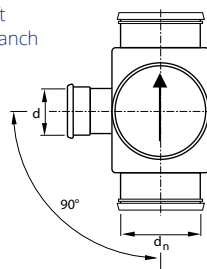

double branch

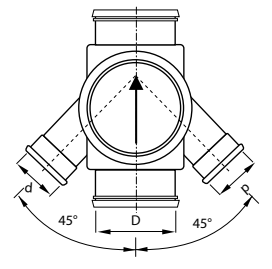

right branch

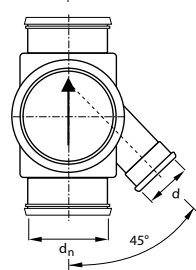

right branch

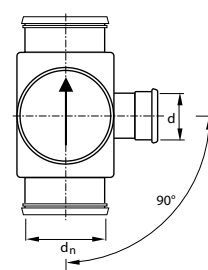

double branch at any angle and diameter combination

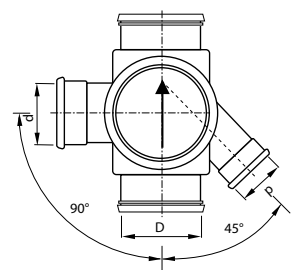

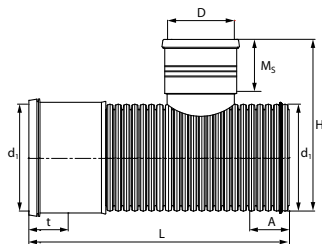

PRO 400 straight-through base for Pragma structural pipes with a smooth wall riser pipe

d ₁ [mm]	D [mm]	M _s [mm]	H [mm]	t [mm]	A [mm]	L [mm]
500	400	310	912	188	225	1035
630	400	310	1050	232	296	1222

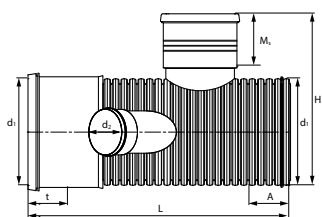

PRO 400 junction base for Pragma structural pipes with a smooth wall riser pipe

d ₁ [mm]	d ₂ [mm]	α [°]	D [mm]	M _s [mm]	H [mm]	t [mm]	A [mm]	L [mm]
500	160	45,90	400	150	752	188	225	1035
	200							
	250							
	315							
400	90							
630	160	45,90	400	150	890	232	296	1222
	200							
	250							
	315							
	400							
500	90							

Smooth wall pipe chambers with a smooth wall riser pipe

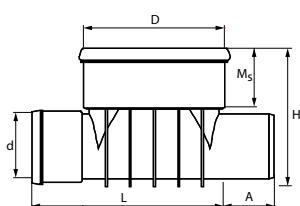

PRO 400 straight-through base for smooth wall pipes with a smooth wall riser pipe

d [mm]	D [mm]	L [mm]	H [mm]	M _s [mm]	A [mm]
160	400	603	383	165	100
200	400	634	423	165	116

Sockets have factory mounted gaskets

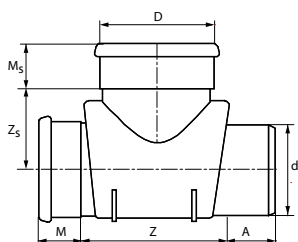

PRO 400 straight-through base for smooth wall pipes with a smooth wall riser pipe

d [mm]	D [mm]	M [mm]	M _s [mm]	Z [mm]	A [mm]	Z _s [mm]
250	400	130	150	730	145	328
315	400	138	150	710	163	298
400	400	150	150	688	184	258

Sockets have factory mounted gaskets

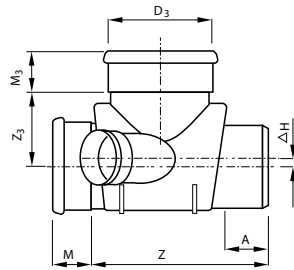
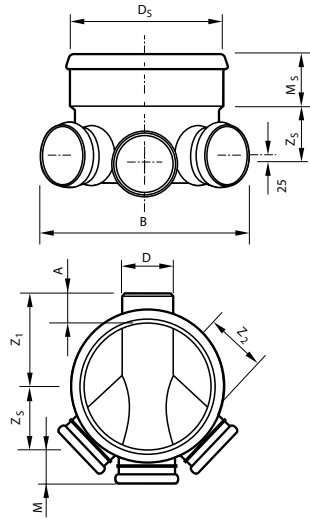

PRO 400 junction base for smooth wall pipes with a smooth wall riser pipe

d_n [mm]	D_s [mm]	M [mm]	M_s [mm]	B [mm]	A [mm]	Z_1 [mm]	Z_2 [mm]	Z_3 [mm]
110	400	67	150	450	66	260	187	143
160	400	107	150	560	87	268	200	168
200	400	123	150	660	101	233	349	188

Sockets have factory mounted gaskets

PRO 400 junction base for smooth wall pipes with a smooth wall riser pipe

d_n [mm]	d [mm]	M [mm]	M_s [mm]	Z [mm]	A [mm]	Z_s [mm]	ΔH [mm]
250	110	130	150	720	135	328	75
250	160	130	150	720	135	328	75
250	200	130	150	720	135	328	75
250	250	130	150	720	135	328	75
315	110	138	150	702	155	298	43
315	160	138	150	702	155	298	43
315	200	138	150	702	155	298	43
315	250	138	150	702	155	298	0
315	315	138	150	702	155	298	43
400	110	150	150	680	176	258	0
400	160	150	150	680	176	258	0
400	200	150	150	680	176	258	0
400	250	150	150	680	176	258	0
400	315	150	150	680	176	258	0

Sockets have factory mounted gaskets
Other chamber base configurations are available upon Customer request.

configurations of junction bases

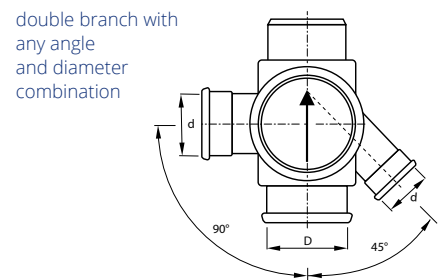
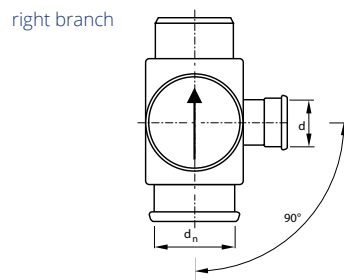
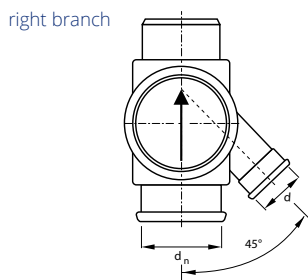
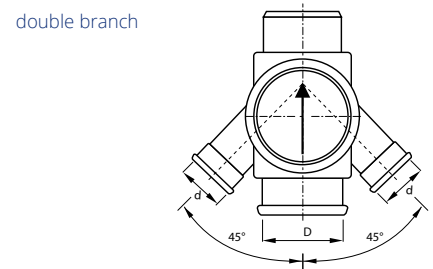
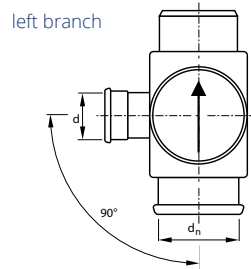
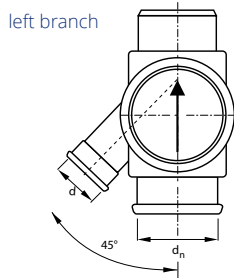

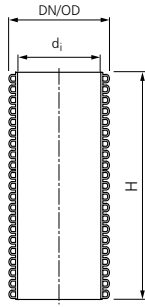

PP-B double wall structural riser pipe		
DN/OD [mm]	d _{i min.} [mm]	H [mm]
400	348	2000
400	348	6000

Nominal stiffness ≥ 8 kN/m² (black)

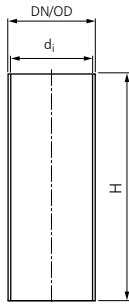

PVC-U riser pipe		
DN/OD [mm]	d _i [mm]	H [mm]
400	380,4	2000
400		6000

Nominal stiffness ≥ 4 kN/m²
EN 13476-2

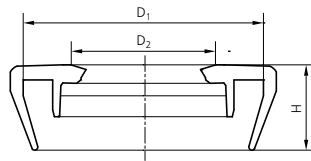

Telescopic gasket for a PP-B DW riser pipe				
DN/OD [mm]	Pipe type	D ₁ [mm]	D ₂ [mm]	H [mm]
400	double wall pipe	399	315	72

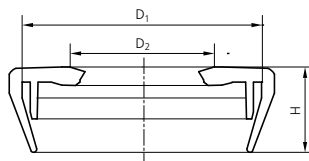

Telescopic gasket for a PVC-U riser pipe				
DN/OD [mm]	Pipe type	D ₁ [mm]	D ₂ [mm]	H [mm]
400	PVC-U	399	315	72

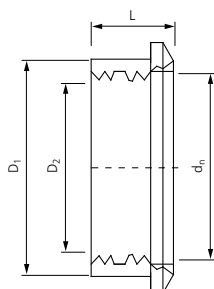

In-situ four lip gasket				
d _n [mm]	size [mm]	D ₁ [mm]	D ₂ [mm]	L [mm]
110	110/138	142	138	65
160	160/186	190	186	65
200	200/226	233	226	65
250	250/276	287	276	65
315	315/341	351	341	65

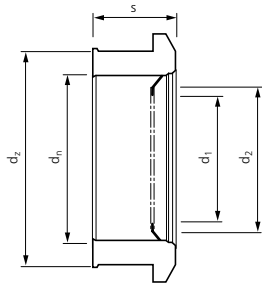

Drainage chamber gasket

d_n [mm]	d_1 [mm]	d_2 [mm]	d_z [mm]	s [mm]	Hole diameter [mm]
110	80	100	124	47	120

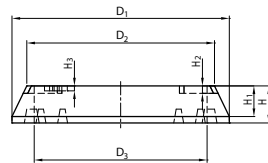
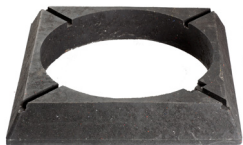

Thermoplastic cone for class D telescope

Type	Class [kN]	Size [mm]	D_1 [mm]	D_2 [mm]	D_3 [mm]	H_1 [mm]	H_2 [mm]	H_3 [mm]	H [mm]
TX315PO	D400	380 x380	340	380	350	62	16	10	75

Cone support surface is 973.88 cm²

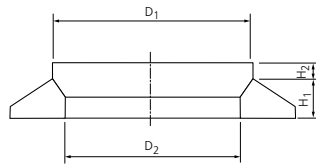

Reinforced concrete cone with a concrete cover

d_n [mm]	D_1 [mm]	D_2 [mm]	D_1 [mm]	H_2 [mm]	Class [kN]
400	620	420	80	60	70

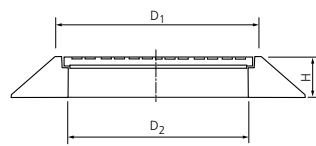

Reinforced concrete cone with a cast iron cover

d_n [mm]	D_1 [mm]	D_2 [mm]	H [mm]	Class [kN]
400	550	410	200	100

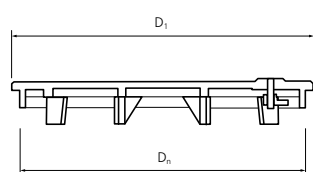

T15 cast iron cover for a PP-B riser pipe

DN/OD [mm]	D_1 [mm]	Type	Class [kN]	Pipe type SN [kN/m ²]
400	444	T15 DW	A15	double wall pipe 8

PRO 425

PRO 425 SEWER CHAMBERS

PVC-U pipe chambers with a PP-B structural riser pipe

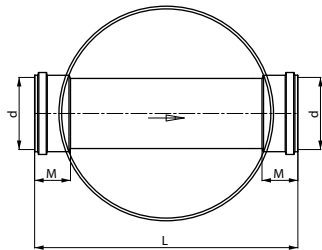
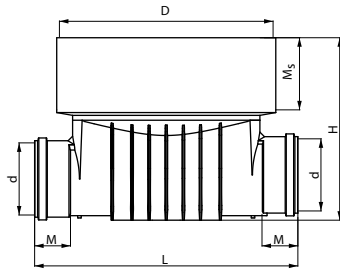

PRO 425 straight-through base for smooth wall pipes with a PP-B structural riser pipe

d [mm]	D [mm]	M _s [mm]	M [mm]	H [mm]	L [mm]
160	478	160	80	420	584
200	478	160	80	460	620
250	478	160	130	633	897
315	478	160	138	635	870
400	478	160	150	652	864

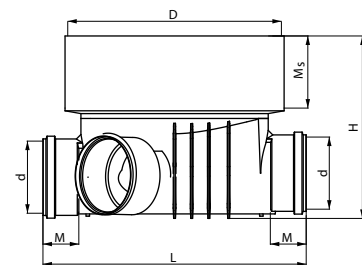
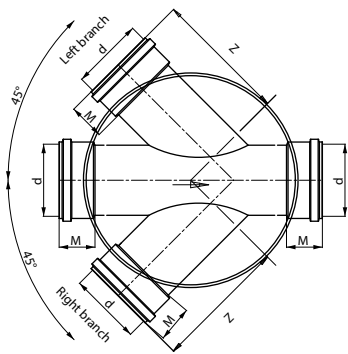

PRO 425 junction base for smooth wall pipes with a PP-B structural riser pipe

dn [mm]	d [mm]	M [mm]	M _s [mm]	Z [mm]	A [mm]	Z _s [mm]	ΔH [mm]
250	160	130	160	720	135	328	75
250	200	130	160	720	135	328	75
250	250	130	160	720	135	328	75
315	160	138	160	702	155	298	43
315	200	138	160	702	155	298	43
315	250	138	160	702	155	298	0
315	315	138	160	702	155	298	43
400	160	150	160	680	176	258	0
400	200	150	160	680	176	258	0
400	250	150	160	680	176	258	0
400	315	150	160	680	176	258	0

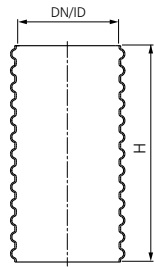

PP-B SN4 single wall riser pipe

DN/ID [mm]	H [mm]
425	2000
425	6000

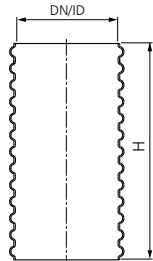

PP-B SN2 single wall riser pipe

DN/ID [mm]	H [mm]
425	2000
425	6000

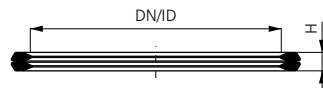

Telescopic seal for SW 425 SN2/SN4 PP-B riser pipe

DN/ID [mm]	Pipe type	D ₁ [mm]	H [mm]
425	single wall pipe	396	30

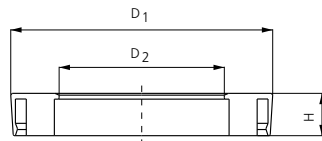

425/315 telescopic seal

DN/ID [mm]	Pipe type	D ₁ [mm]	D ₂ [mm]	H [mm]
425	single wall pipe	484	315	78

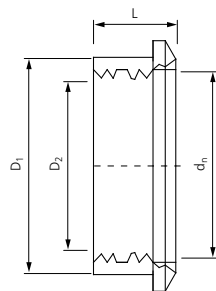

In-situ four lip gasket

d _n [mm]	size [mm]	D ₁ [mm]	D ₂ [mm]	L [mm]
110	110/138	142	138	65
160	160/186	190	186	65
200	200/226	233	226	65
250	250/276	287	276	65
315	315/341	351	341	65

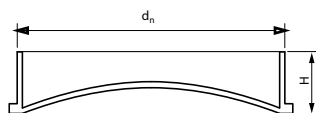

Chamber bottom with a gasket

d _n [mm]	H [mm]
425	134

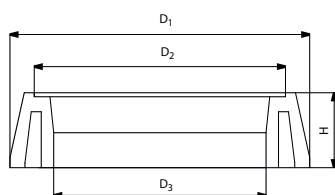

Thermoplastic cone for class D telescope

Type	Class [kN]	Size [mm]	D ₁ [mm]	D ₂ [mm]	D ₃ [mm]	H [mm]
T3 400	400	600	600	503	425	150

Telescopes for PRO 425 chambers

NOTE:
The telescopes do not have a gasket for the riser pipe

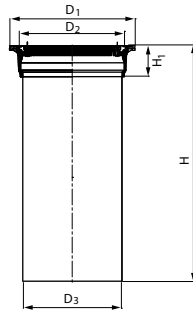

Telescope with a full cover

Type	Class [kN]	Size [mm]	D ₁ [mm]	D ₂ [mm]	D ₃ [mm]	H ₁ [mm]	H [mm]
A15	15	500	500	407	400	100	542
B125	125	500	500	405	400	100	586
C250	250	500	500	405	400	100	586
D400	400	500	500	405	400	100	586

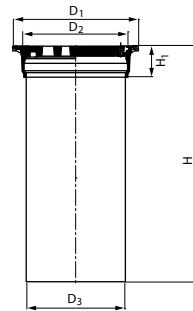

Telescope with a gully

Type	Class [kN]	Size [mm]	D ₁ [mm]	D ₂ [mm]	D ₃ [mm]	H ₁ [mm]	H [mm]
A15	15	500	500	406	400	100	542
B125	125	500	500	406	400	100	586
C250	250	500	500	406	400	100	586
D400	400	500	500	406	400	100	586

Telescopes and accessories for PRO 315, PRO 400 and PRO 425 chambers

NOTE:
The telescopes do not have a gasket for the 400 mm riser pipe

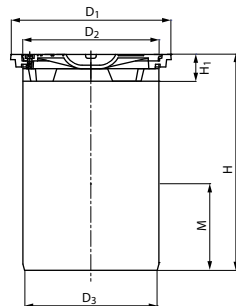

T05 D telescope with a cast iron cover

Type	Class [kN]	Size [mm]	D ₁ [mm]	D ₂ [mm]	D ₃ [mm]	H ₁ [mm]	H [mm]	M [mm]
T05 D	15	370 x 370	370	316	315	62	395	200

Manhole cover fixing - M8 screw

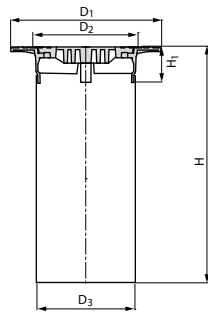

A15 thermoplastic telescope with a full cover

Type	Class [kN]	Size [mm]	D ₁ [mm]	D ₂ [mm]	D ₃ [mm]	H ₁ [mm]	H [mm]
A15	15	397 x 397	397	296	315	132	534

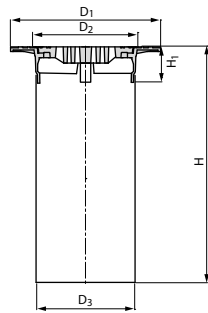

A15 thermoplastic telescope with a gully

Type	Class [kN]	Size [mm]	D ₁ [mm]	D ₂ [mm]	D ₃ [mm]	H ₁ [mm]	H [mm]
A15	15	397 x 397	397	296	315	132	557

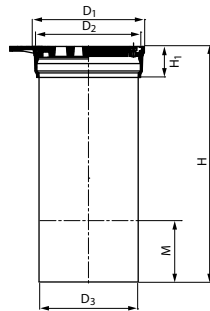

T05 DK telescope with a cast iron gully

Type	Class [kN]	Size [mm]	D ₁ [mm]	D ₂ [mm]	D ₃ [mm]	H ₁ [mm]	H [mm]	M [mm]
T05 D	15	370 x 370	370	316	315	62	395	200

Manhole cover fixing – M8 screw
 The size of the holes is 233.49 cm², which is 34.2% of the surface area.

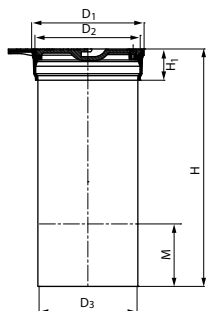

T30 telescope with a cast iron cover

Type	Class [kN]	Size [mm]	D ₁ [mm]	D ₂ [mm]	D ₃ [mm]	H ₁ [mm]	H [mm]	M [mm]
T30	125	360 x 360	360	337	315	100	540	200

Telescopic pipe connection is integrated with a cast iron body.
 Manhole cover fixing – M10 screw.

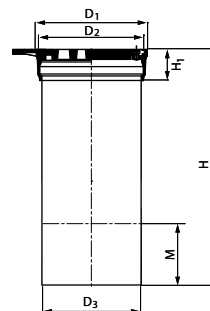

T30 K telescope with a cast iron gully

Type	Class [kN]	Size [mm]	D ₁ [mm]	D ₂ [mm]	D ₃ [mm]	H ₁ [mm]	H [mm]	M [mm]
T30K	125	360 x 360	360	337	315	100	540	200

Telescopic pipe connection is integrated with a cast iron body.
 Manhole cover fixing – M10 screw.
 The size of the holes is 264.31 cm², which is 36.41% of the surface area.

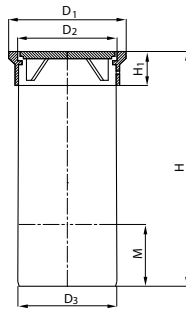

B125 telescope with a cast iron cover

Type	Class [kN]	Size [mm]	D ₁ [mm]	D ₂ [mm]	D ₃ [mm]	H ₁ [mm]	H [mm]	M [mm]
B125	125	380 x 380	380	332	315	110	540	200

Manhole cover fixing – M10 screw.

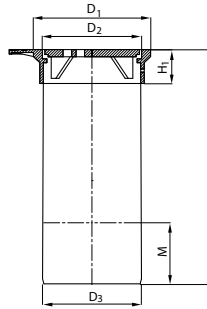

B125 K telescope with a cast iron gully

Type	Class [kN]	Size [mm]	D ₁ [mm]	D ₂ [mm]	D ₃ [mm]	H ₁ [mm]	H [mm]	M [mm]
B125K	125	380 x 380	380	332	315	110	540	200

Manhole cover fixing – M10 screw.
The size of the holes is 31% of the surface area.

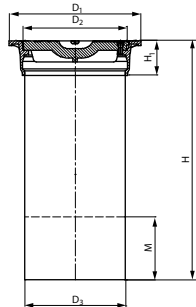

T40 telescope with a cast iron cover

Type	Class [kN]	Size [mm]	D ₁ [mm]	D ₂ [mm]	D ₃ [mm]	H ₁ [mm]	H [mm]	M [mm]
T40	400	420	420	333	315	110	540	200

Telescopic pipe connection is integrated with a cast iron body.
Manhole cover fixing – M10 screw.

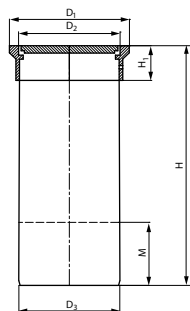

D400 telescope with a cast iron cover

Type	Class [kN]	Size [mm]	D ₁ [mm]	D ₂ [mm]	D ₃ [mm]	H ₁ [mm]	H [mm]	M [mm]
D400	400	380 x 380	380	322	315	90	540	200

Manhole cover fixing – M10 screw.

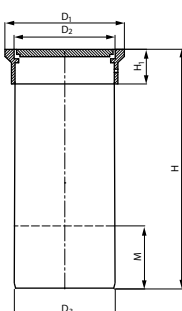

D400 K telescope with a cast iron gully

Type	Class [kN]	Size [mm]	D ₁ [mm]	D ₂ [mm]	D ₃ [mm]	H ₁ [mm]	H [mm]	M [mm]
D400K	400	380 x 380	380	322	315	90	540	200

Manhole cover fixing – M10 screw. The size of the holes is 240 cm²

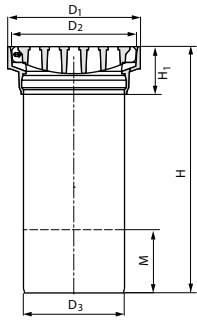

T50 K telescope with a cast iron gully

Type	Class [kN]	Size [mm]	D ₁ [mm]	D ₂ [mm]	E ₁ [mm]	E ₂ [mm]	D ₃ [mm]	H ₁ [mm]	H [mm]	M [mm]
T50K	250	420 x340	420	398	340	310	315	150	540	200

Telescopic pipe connection is integrated with a cast iron body
 Manhole cover fixing - M10 screw
 The cover is mounted on hinges
 The size of the holes is 419 cm², which is 43% of the surface area

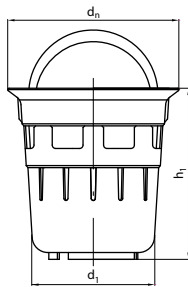

Catchment bucket

Type	d _n [mm]	h ₁ [mm]	d ₁ [mm]
250*	258	244	187
250**	260	254	205

* made of PE
 ** made of galvanized steel

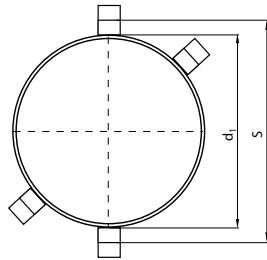
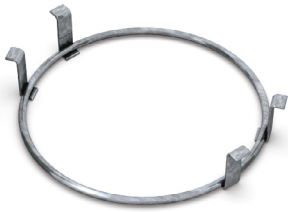

Steel grip for a catchment bucket

Manhole type	S [mm]	d ₁ [mm]
T30K	291	232

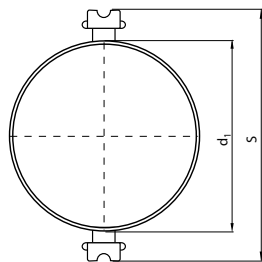

Steel grip for a catchment bucket

Manhole type	S [mm]	d ₁ [mm]
T50K	295	248

PRO 600

PRO 600 SEWER CHAMBERS

Chambers for smooth wall and Pragma pipes with a PP-B structural riser pipe

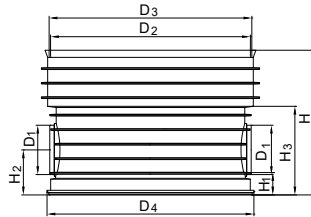

PRO 600 Straight-through bases

D ₁ [mm]	α [°]	D ₂ [mm]	D ₃ [mm]	D ₄ [mm]	H ₁ [mm]	H ₂ [mm]	H ₃ [mm]	H [mm]
160	0°	688	696	712	75	155	300	498
200					78	175	300	498
250					71	204	410	608
315					88	230	410	608
200	90°				88	203,5	433	498

The bases have Eurosocket type sockets for connection with a smooth wall or a Pragma pipe for Pragma structural pipes. A Pragma pipe should be connected with an Eurosocket using a PVC socket adapter. A smooth wall pipe should be connected with a Pragma socket using a stabilizing ring with a gasket.

straight-through bases configurations

straight-through 0°

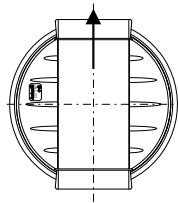

straight-through 90°

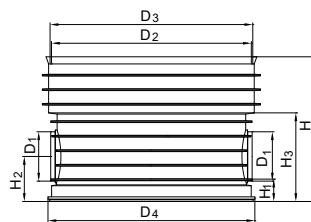
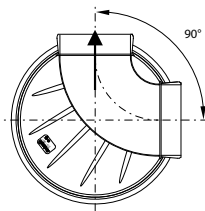

PRO 600 Straight-through bases with a side branch

D ₁ [mm]	α [°]	D ₂ [mm]	D ₃ [mm]	D ₄ [mm]	H ₁ [mm]	H ₂ [mm]	H ₃ [mm]	H [mm]
160	90°	688	696	712	83	155	288	498
200	(270°)				75	175	300	498
160	90°				83	155	288	498
200	(90°)				75	175	300	498

configuration of bases with one branch

junction 90° (270°)

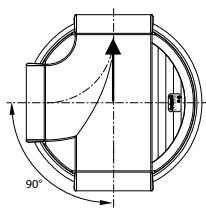

junction 90° (90°)

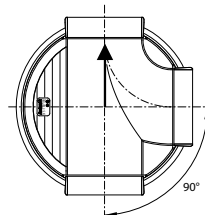

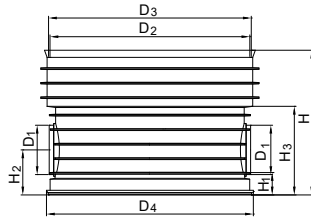

PRO 600 Straight-through bases with two side branches

D ₁ [mm]	α [°]	D ₂ [mm]	D ₃ [mm]	D ₄ [mm]	H ₁ [mm]	H ₂ [mm]	H ₃ [mm]	H [mm]
160	45° (225°)	688	696	712	75	155	300	498
200	45° (135°)				75	175	300	498
250	88				203,5	433	498	
160	90° (270°)	688	696	712	75	155	300	498
200	90° (90°)				75	175	300	498
250	88				203,5	433	608	
315	88				233,5	433	608	

**configuration
of bases
with two branches**

junction 45° (225°), 45° (135°)

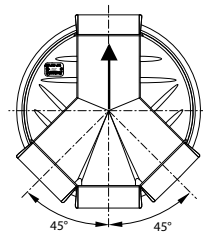

junction 90° (270°), 90° (90°)

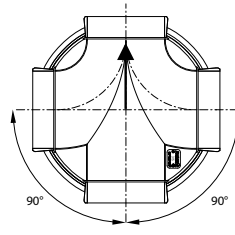

PRO 630

PRO 630 SEWER CHAMBERS

Chambers for smooth wall and Pragma pipes with a PP-B structural riser pipe

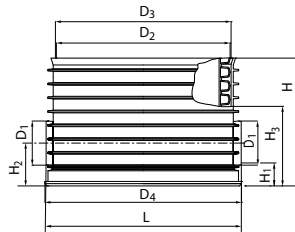

The bases have Eurosocket type sockets for connection with a smooth wall or a Pragma pipe for Pragma structural pipes. A Pragma pipe should be connected with an Eurosocket using a PVC socket adapter. A smooth wall pipe should be connected with a Pragma socket using a stabilizing ring with a gasket.

PRO 630 Straight-through bases

D ₁ [mm]	α [°]	D ₂ [mm]	D ₃ [mm]	D ₄ [mm]	H ₁ [mm]	H ₂ [mm]	H ₃ [mm]	H [mm]	L [mm]						
160	0°	630	637	712	75	155	300	473	693						
200					78	175	300	473	693						
250					79	204	410	583	693						
315					72,5	230	410	583	693						
400					88	233,5	433	613	1050						
250	45°				630	637	712	79	203,5	433	613	1018			
315								79	233,5	433	613	1050			
250	90°							630	637	712	79	203,5	433	613	1018
315											79	233,5	433	613	1050

straight-through bases configurations

straight-through 0°

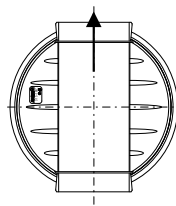

straight-through 45°

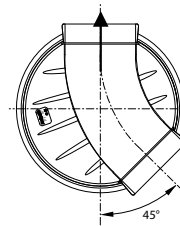

straight-through 90°

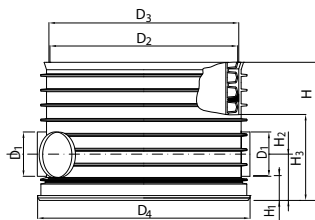
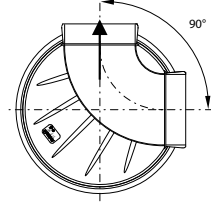

PRO 630 Straight-through bases with a side branch

D ₁ [mm]	α [°]	D ₂ [mm]	D ₃ [mm]	D ₄ [mm]	H ₁ [mm]	H ₂ [mm]	H ₃ [mm]	H [mm]									
160	45° (225°)	630	637	712	83	155	288	473									
200					83	175	288	473									
250					88	203,5	433	613									
315	88				233,5	433	613										
160	45° (135°)				630	637	712	83	155	288	473						
200								83	175	288	473						
160	90° (270°)							630	637	712	75	155	288	473			
200											75	175	300	473			
160	90° (90°)										630	637	712	75	155	288	473
200														75	175	300	473

configuration of bases with one branch

junction 45° (225°)

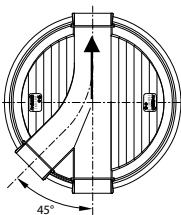

junction 45° (135°)

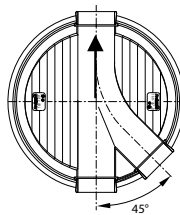

junction 90° (270°)

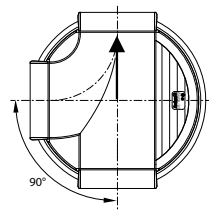

junction 90° (90°)

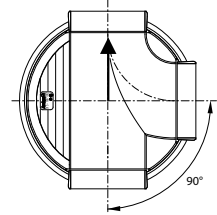

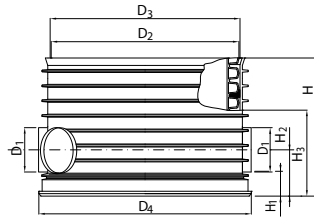
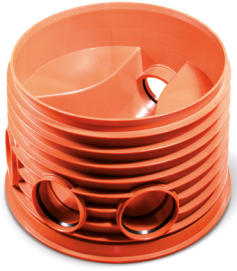

PRO 630 Straight-through bases with two side branches								
D ₁ [mm]	α [°]	D ₂ [mm]	D ₃ [mm]	D ₄ [mm]	H ₁ [mm]	H ₂ [mm]	H ₃ [mm]	H [mm]
160	45° (225°)	630	637	712	75	155	300	473
200	45° (135°)				75	175	300	473
250					88	203,5	433	613
160	90° (270°)				75	155	300	473
200	90° (90°)				75	175	300	473
250	90° (90°)				88	203,5	433	613
315	90° (90°)				88	233,5	433	613
160	45° (225°)				83	155	288	463
200	90° (90°)				83	175	288	463
160	90° (270°)				83	155	288	463
200	45° (135°)				83	175	288	463

configuration of bases with two branches

junction 45° (225°), 45° (135°)

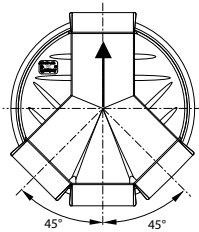

junction 90° (270°), 90° (90°)

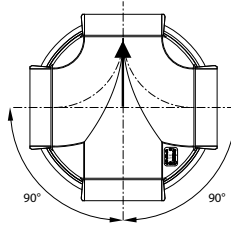

junction 45° (225°), 90° (90°)

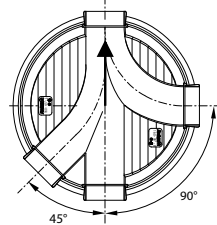

junction 90° (270°), 45°(135°)

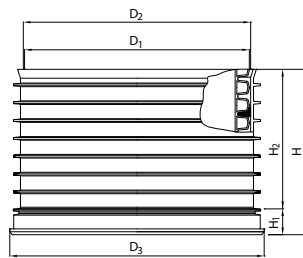
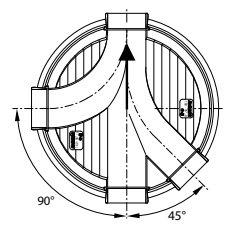

PP-B closed (catchment) base					
D ₁ [mm]	D ₂ [mm]	D ₃ [mm]	H ₁ [mm]	H ₂ [mm]	H [mm]
630	637	712	48	425	473



PP-B riser pipe gasket	
d _n [mm]	
630	

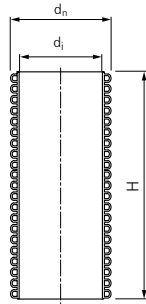

PP-B double wall riser pipe

d_n [mm]	$d_{i\ min.}$ [mm]	H [mm]
630	546	2000
630	546	6000

Nominal stiffness $\geq 8\text{kN/m}^2$ (brown) or $\geq 4\text{kN/m}^2$ (black)

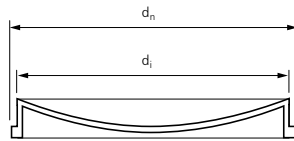

PP-B chamber bottom

d_n [mm]	d_i [mm]
630	546

Note:

For chambers made on site using a SN 8 structural pipe and a bottom, it is recommended to concrete the bottom

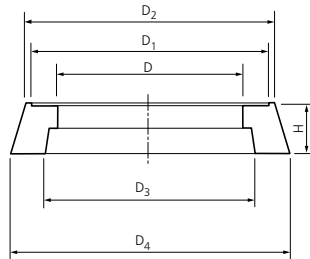

Thermoplastic T3 615/700 load distribution cone

DN [mm]	D [mm]	D_1 [mm]	D_2 [mm]	D_3 [mm]	D_4 [mm]	H [mm]
615/700	615	800	840	700	950	180

Before setting the cast iron manhole cover, apply asphalt and rubber binder, e.g. Laterbit B6 Plus, on the upper surface of the cone.

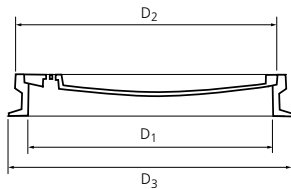

Sewer manhole cover

DN [mm]	D_1 [mm]	D_2 [mm]	D_3 [mm]	Class [kN]
600	600	640	678	A15
		678	750	B125
		678	750	C250
		682	750	D400

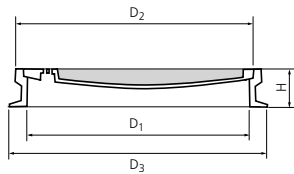

Cast iron-concrete manhole cover

DN [mm]	D_1 [mm]	D_2 [mm]	D_3 [mm]	H [mm]	Class [kN]
600	600	678	754	115	C 250
600	600	682	754	115	D 400

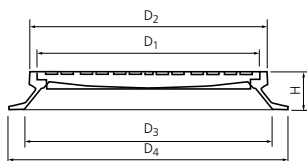

Expanded sewer manhole cover 710/600

DN [mm]	D_1 [mm]	D_2 [mm]	D_3 [mm]	D_4 [mm]	H [mm]	Class [kN]
710/600	620	640	600	800	52	A15
710/600	640	682	710	800	115	B125
						C250
						D400

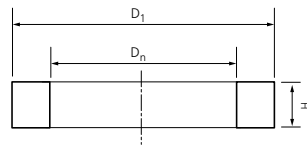

Thermoplastic spacer ring			
DN [mm]	D ₁ [mm]	H [mm]	Class [kN]
600	780	100	D400
600	780	150	D400

Before setting a cast iron manhole cover, apply asphalt and rubber binder, e.g. Laterbit B6 Plus, on the upper surface of the ring.

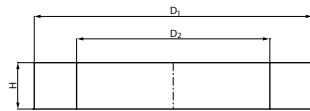

Concrete ring for a telescope for an A-D class manhole cover			
D ₁ [mm]	D ₂ [mm]	H [mm]	Class [kN]
800	600	130	D400

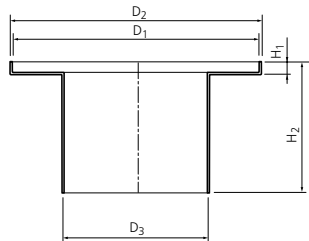

PP telescope					
DN [mm]	D ₁ [mm]	D ₂ [mm]	D ₃ [mm]	H ₁ [mm]	H ₂ [mm]
600	845	860	537	38	507

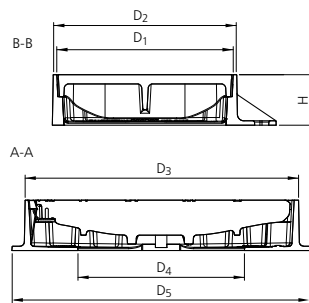

Rain gully							
DN [mm]	D ₁ [mm]	D ₂ [mm]	D ₃ [mm]	D ₄ [mm]	D ₅ [mm]	H [mm]	Class [kN]
600	402	417	622	380	680	115	D 400

Gully 400 x 600, ¾ flange with a hinge and a catch

Inlet surface 1018 cm²

Closed frame with a support enabling installation of a dirt catchment tank, with a safe, deep, three-point setting of the gully in the frame, preventing faulting. Precious steel hinge

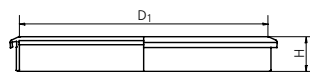

Telescope Seal for PPDW pipes SN8		
DN [mm]	D ₁ [mm]	H [mm]
600	535	72

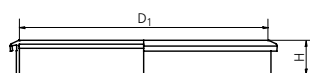

Telescope Seal for PPDW pipes SN4		
DN [mm]	D ₁ [mm]	H [mm]
600	535	72

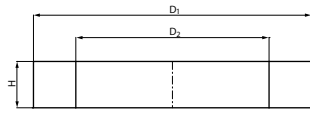

Concrete ring for an A-D class manhole cover			
D_1 [mm]	D_2 [mm]	H [mm]	Class [kN]
1150	650	200	D400

Used around 630 mm riser pipe

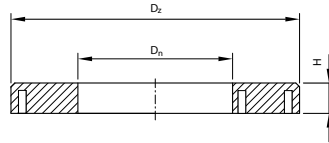

Adapter TX765/410			
D_n [mm]	D_z [mm]	H [mm]	Klasa [kN]
410	765	80	D400

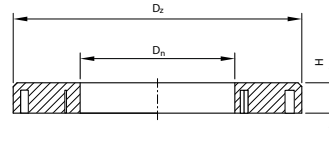

Adapter TX765/420/470			
D_n [mm]	D_z [mm]	H [mm]	Klasa [kN]
420x470	765	80	D400

PRO 800, PRO 1000

SEWER CHAMBERS PRO 800, PRO 1000

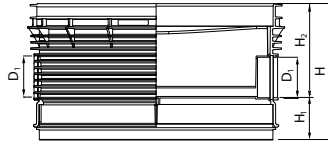
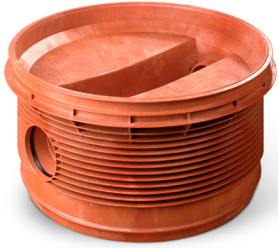

The bases have Eurosocket type sockets for connection with a smooth wall or a Pragma pipe for Pragma structural pipes. A Pragma pipe should be connected with an Eurosocket using a PVC socket adapter. A smooth wall pipe should be connected with a Pragma socket using a stabilizing ring with a gasket

PP-B PRO 800, PRO 1000 straight-through chambers base

D ₁ [mm]	α [°]	PRO 800			PRO 1000		
		H ₁ [mm]	H ₂ [mm]	H [mm]	H ₁ [mm]	H ₂ [mm]	H [mm]
160	0°	170	375	545	165	425	590
200		170	375	545	165	425	590
250		170	375	545	165	425	590
315		165	525	690	165	575	740
400		165	525	690	165	575	740
250	90° (90°)				210	460	670
315					210	460	
400					215	455	
250	90° (270°)				210	460	
315					210	460	
400					215	455	

straight-through bases configurations

straight-through 0°

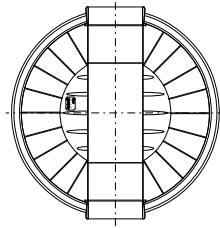

straight-through 90° (90°)

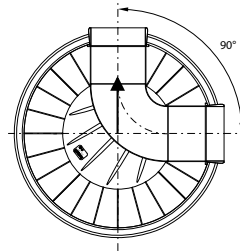

straight-through 90° (270°)

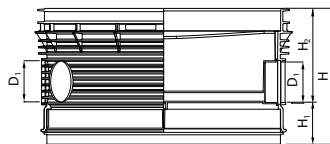
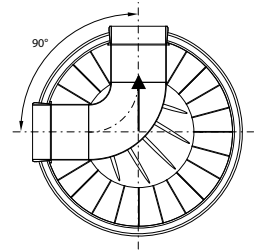

PP-B PRO 1000 straight-through bases with two side branches

D ₁ [mm]	α [°]	H ₁ [mm]	H ₂ [mm]	H [mm]
160	45° (225°), 45° (135°)	167	418	585
200		167	418	
250	90° (270°), 90° (90°)	205	465	670
315		205	465	
250		210	460	
315		215	455	

configuration of bases with two branches

junction 45° (225°), 45° (135°)

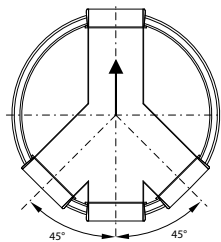

junction 90° (270°), 90° (90°)

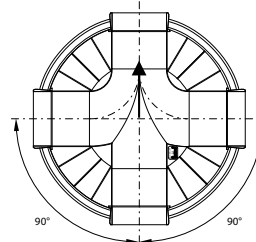

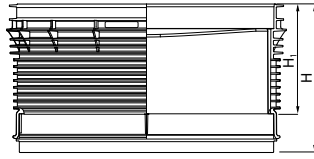

PP-B closed base		
DN/ID [mm]	H ₁ [mm]	H [mm]
800	500	670
1000	500	670

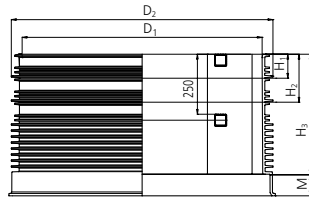

PP-B ring with laddersteps						
DN/ID [mm]	D ₁ [mm]	D ₂ [mm]	H ₁ [mm]	H ₂ [mm]	H ₃ [mm]	M [mm]
800	800	890	100	200	500 1000 1500	90
1000	1000	1090	100	200	500 1000 1500	90

Anti-slip laddersteps with the section of 30 x 30 mm, made of GRP

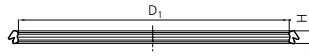

EPDM connection gasket		
DN/ID [mm]	D ₁ [mm]	H [mm]
800	822	42
1000	1022	

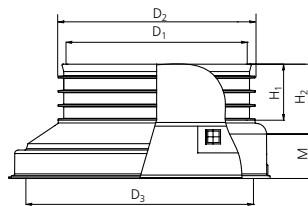

PP-B cone						
DN/ID [mm]	D ₁ [mm]	D ₂ [mm]	D ₃ [mm]	H ₁ [mm]	H ₂ [mm]	M [mm]
800/630	637	692	866	197	312	90
1000/630	637	692	1066	197	530	90

The cone is equipped with an anti-slip ladderstep

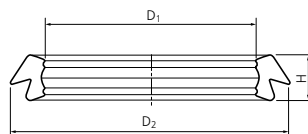

EPDM gasket for a 630 mm cone			
d _n [mm]	D ₁ [mm]	D ₂ [mm]	H [mm]
630	653	716	42

For sealing the connection with a concrete or thermoplastic load distribution ring

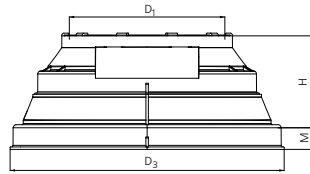

PP-B cone with teeth for a 630 telescope					
Name	D ₁ [mm]	D ₂ [mm]	D ₃ [mm]	M [mm]	H [mm]
800/630 cone with teeth	637	-	910	90	152
1000/630 cone with teeth	637	692	1110	90	370
1000/630 cone with teeth and laddersteps	637	-	1110	90	370

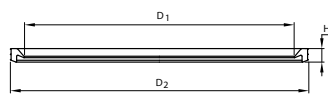

EPDM gasket for a 630 mm telescope			
d _n [mm]	D ₁ [mm]	D ₂ [mm]	H [mm]
630	607	675	38

Insert the seal to the inside of the cone with teeth

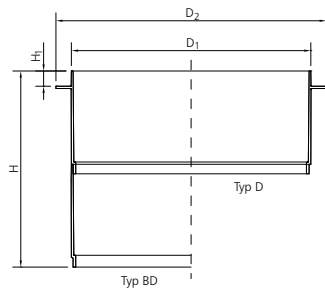

630 mm PP-B telescope						
Type	DN [mm]	D ₁ [mm]	D ₂ [mm]	M [mm]	H [mm]	H ₁ [mm]
BD	630	631	710	25	515	40
D	630	631	710	25	270	40

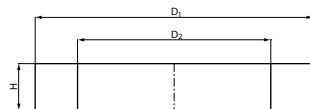

Concrete ring for a 710/600 A-D class expanded manhole cover			
D ₁ [mm]	D ₂ [mm]	H [mm]	Class [kN]
1210	710	200	D400

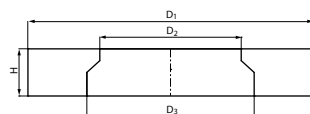

Concrete ring for a 600 A-D class manhole cover				
D ₁ [mm]	D ₂ [mm]	D ₃ [mm]	H [mm]	Class [kN]
1210	600	710	200	D400

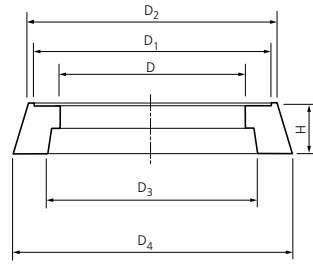

T3 615/700 thermoplastic cone						
DN [mm]	D [mm]	D ₁ [mm]	D ₂ [mm]	D ₃ [mm]	D ₄ [mm]	H [mm]
615/700	615	800	840	700	950	180

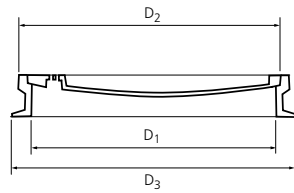

Sewer manhole cover				
DN [mm]	D ₁ [mm]	D ₂ [mm]	D ₃ [mm]	Class [kN]
600	600	640	678	A15
		678	750	B125
		678	750	C250
		682	750	D400

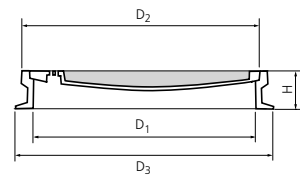

Cast iron-concrete manhole cover					
DN [mm]	D ₁ [mm]	D ₂ [mm]	D ₃ [mm]	H [mm]	Class [kN]
600	600	678	754	115	C 250
600	600	682	754	115	D 400

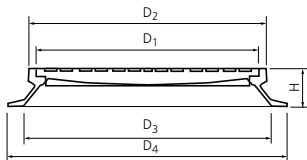

Expanded sewer manhole cover 600 mm						
DN [mm]	D ₁ [mm]	D ₂ [mm]	D ₃ [mm]	D ₄ [mm]	H [mm]	Class [kN]
710/600	620	640	600	800	52	A15
710/600	640	682	710	800	115	B125
						C250
						D400

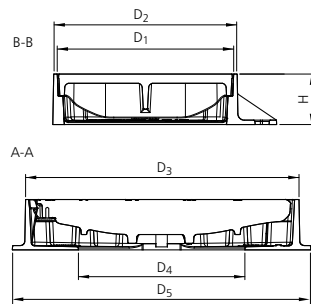

Rain gully							
DN [mm]	D ₁ [mm]	D ₂ [mm]	D ₃ [mm]	D ₄ [mm]	D ₅ [mm]	H [mm]	Class [kN]
600	402	417	622	380	680	115	D 400

Gully 400 x 600, ¾ flange with a hinge and a catch Inlet surface 1018 cm²
 Closed frame with a support enabling installation of a dirt catchment tank, with a safe, deep, three-point setting of the gully in the frame, preventing faulting.
 Precious steel hinge

